

Heating & Hot Water Solutions



Joule Air Source Heatpumps



R32 Low
GWP
Refrigerant



7 Year
Warranty



Quietest
System
on the
Market



Energy class
in water
heating

Contents

Introducing Joule	3
Stelflow	4
Selection Guide	6
Commercial Cylinder Quick Guide	16
Indirect Commercial	17
Multi Energy Commercial	18
Solar Commercial	19
Ordering Guide - Commercial	20
Air Source Heat Pumps	22
How it works?	23
Samsung SmartThings	25
UFH System Options	38
Radiator Specs	41
Solar	41
Acapella Evacuated Tube System	43
Navitas	44
2m/2.5m On Roof System	44
Navitas In Roof System	45
Victorum exhaust air heat pump	46
Benefits Of The Victorium	46
Product History & Development	47
Touchscreen	47
Control Panel	47



Heat Pump Installer Course

The Joule installer heat pump course is designed for heating engineers to give them the additional knowledge required to install and commission Joule heat pump systems. This course is completely free and takes place online. On successfully completing this course you will have the necessary knowledge to Install and Commission any forthcoming projects you have.

Passing the assessments allows the successful candidate to offer a Joule 7 year Warranty



Vist <https://jouleuk.co.uk/training/> to register now

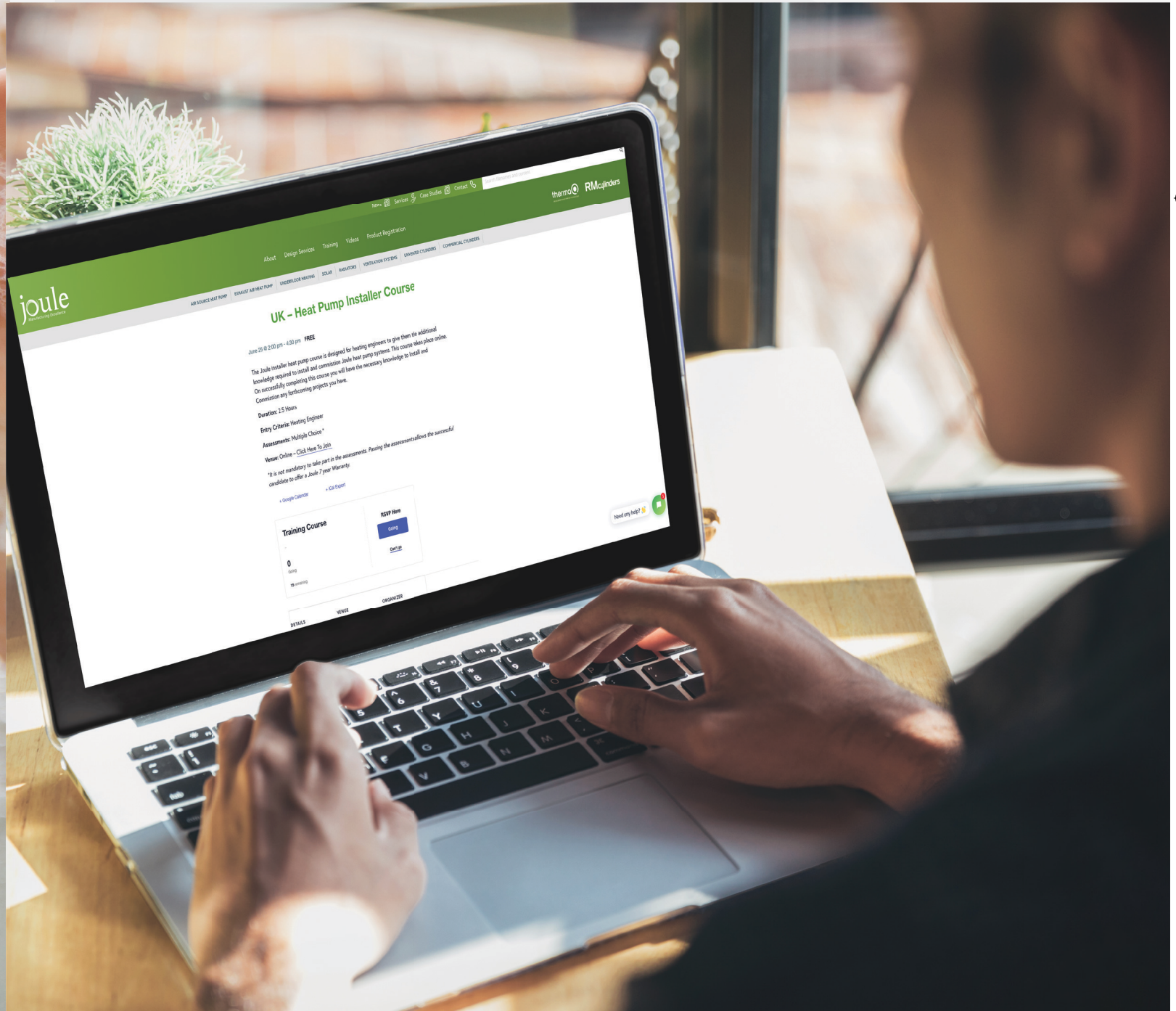

Stelflow

The new standard in unvented hot water generation.



The RM Stelflow has carefully been constructed using quality components and has been designed with performance in mind. Using our many years of involvement within the hot water industry and our knowledge of bringing unvented cylinders to the market we have created a new standard in unvented water storage.

Stelflow offers the following advantages:

- Specially made units manufactured to your own design.
- Full range of slim units available, 60L to 210L, featuring a diameter of only 475mm one of the slimmest on the market.
- A range of horizontal cased units.
- Coil in coil heat exchanger, giving high recovery rates.
- External expansion for reliability and flexible siting.
- Full KIWA product approval.
- Vessel constructed from Duplex Stainless Steel.
- Superior insulation values, with an ODP of 0 and GWP of 1.
- Comprehensive controls and fixing kit from leading manufacturers.

Stelflow offers peace of mind with the following guarantees:

- 25 Year vessel guarantee.
- Stainless Steel stat pocket guaranteed against corrosion.
- All other cylinder components guaranteed for 2 years.
- All units are pickled to ensure longer life.

Stelflow offers many technical benefits:

- Minimum recommended working pressure 1 bar & maximum 3 bar.
- All cylinder connections are 22mm compression.
- Minimum water supply 1.5 Bar, 20 Litres/Min.
- Primary coil circuit must be fully pumped, gravity coils are available by special order.
- All units available as vented cylinders.
- Control settings:
 1. Pressure reducing valve set at 3 Bar.
 2. Expansion relief valve set at 6 bar.
 3. Temperature and pressure relief valve at 7 bar and 90°C.
 4. High Limit stat set at 85°C.



STELFLOW
UNVENTED HOT WATER STORAGE
Manufactured in The UK By RM Cylinders
www.rm-cylinders.com - 01502 32 80 99

Fitted with industry renowned Caleffi safety components



Screwed connections with compression fittings supplied as standard

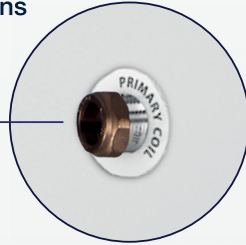

Smooth tube, high-efficiency coils as standard

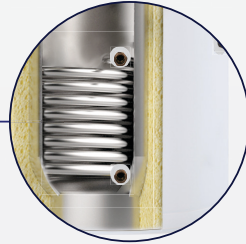

Inlet Control Group

TZG-3.0-0.75L
TZG-3.0-0001L



T&P Valve

TZ9-4.0-0000.5
TZ9-4.0-000.75



Cylinder Stat

TZC-D-0000000Z



Tundish

TZU-0000



Zone Valve

TZM-I-0000



Expansion Vessel

TV-P-000012L TV-P-000019L
TV-P-000024L TV-P-000035L
TV-P-000050L



Immersion Heater

TH-L-14-3-1

Selection Guide

			Kg	Kg		L		nWh%	Mins	W	kWh/ ANNUUM	Kw	Kw
			Weight Empty	Weight Full	Load Profile	Water Volume	ERP Energy Rating	Energy Efficiency	Reheat Time Indirect	Standing Loss	Annual Energy Usage	Primary Coil Rating	Solar Coil Rating
60	TRSMVI-0060SFC	Indirect Slimline	21	81		60	B		13.4	38		16.4	
	TRSMVD-0060SFC	Direct Slimline	19	79	M	60	C	36		38	1439		
120	TRSMVD-0120LFB	Direct	26	146	M	120	C	34		46	1515		
	TRSMVI-0120LFB	Indirect	30	146		120	B		19.05	46		15.63	
	TRSMVD-0120SFC	Direct Slimline	26	146	M	120	C	34		52	1493		
	TRSMVI-0120SFC	Indirect Slimline	30	150		120	B		19.05	52		15.63	
	TRSMHI-0120LFB	Horizontal Indirect	30	146		120	C		15.82	54		16.54	
150	TRSMVD-0150LFB	Direct	33	183	L	150	C	33		53	1547		
	TRSMVI-0150LFB	Indirect	38	184		150	B		23.71	53		16.33	
	TRSMVD-0150SFC	Direct Slimline	33	183	M	150	C	34		60	1527		
	TRSMVI-0150SFC	Indirect Slimline	38	188		150	C		23.71	60		16.33	
	TRSMHI-0150LFB	Horizontal Indirect	38	184		150	C		20.58	63		18.15	
	TRSMVS-0150LFB	Solar Twin	40	182		150	B		16.05	53		16.33	17.49
150 AIR	TRIMVI-0150LFB	Indirect Air	38	172		150	B		25.3	50		12.45	
	TRIMVD-0150SFB	Direct Slimline Air	33	164	M	131	C	36		57	1651		
	TRIMVI-0150SFB	Indirect Slimline Air	38	172		150	B		19.09	57		16.45	
180	TRSMVD-0180LFB	Direct	38	218	L	180	C	36		58			
	TRSMVI-0180LFB	Indirect	42	218		180	B		29.20	58		15.9	
	TRSMVD-0180SFC	Direct Slimline	38	218	M	180	C	34		64			
	TRSMVI-0180SFC	Indirect Slimline	42	222		180	C		29.02	64		15.9	
	TRSMVH-0180LFB	High Gain Indirect	55	221		180	B		10.87	44			
	TRSMVH-0180SFC	Slim High Gain Ind	45	217		180	C						
	TRSMHI-0180LFB	Horizontal Indirect	42	218		180	C		22.43	71		17.31	
	TRSMVS-0180LFB	Solar Twin	45	216		180	B		19.5	58		15.9	18.85
	TRIMVD-0180LFB	Direct Air	38	207	L	169	C	37		55	2784		
	TRIMVI-0180LFB	Indirect Air	42	207		180	B		26.16	55		14.27	
180 AIR	TRIMVD-0180SFB	Direct Slimline Air	38	197	L	159	C	37		63	2815		
	TRIMVI-0180SFB	Indirect Slimline Air	42	207		180	B		21.79	63		18.06	
	TRIMVS-0180LFB	Solar Twin Air	42	203		161	B		36	55		13.8	12.91

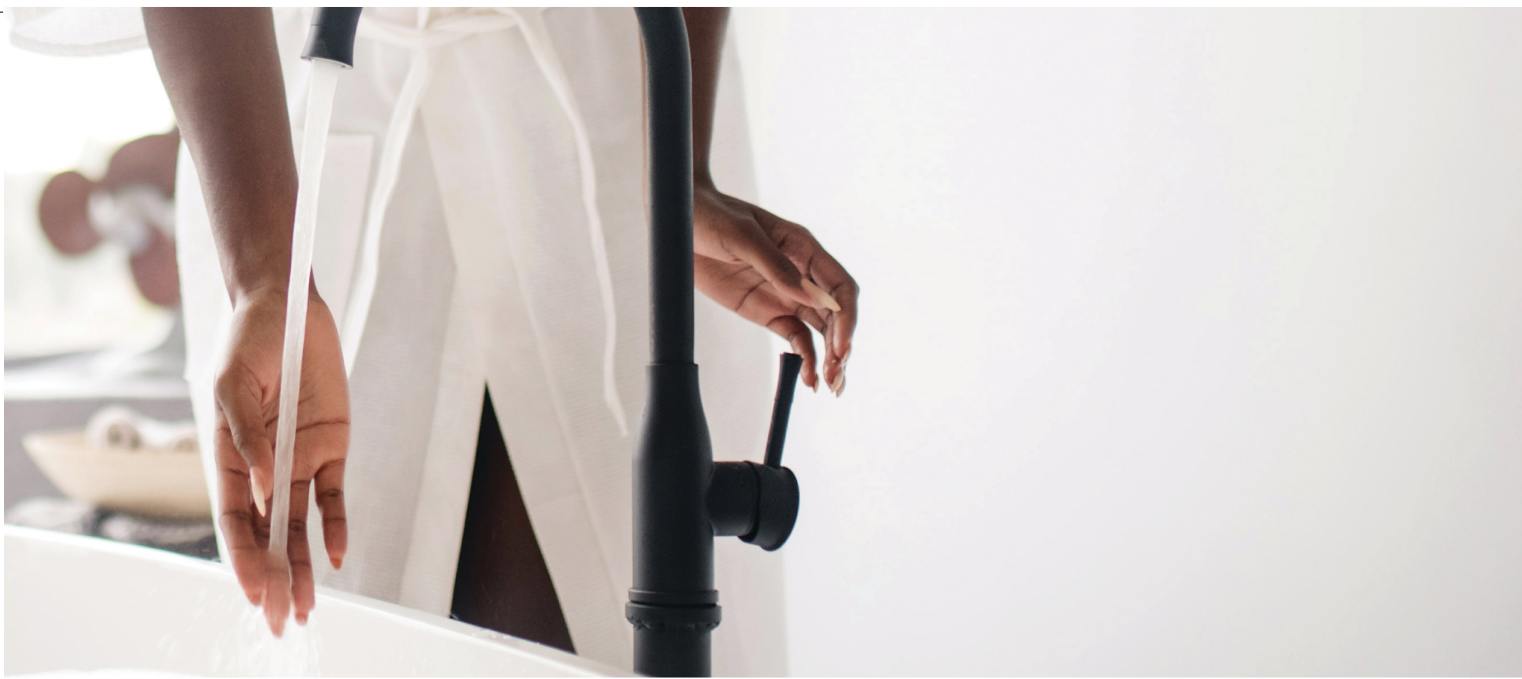

Selection Guide

			Kg	Kg		L		nWh%	Mins	W	kWh/ ANNUM	Kw	Kw
			Weight Empty	Weight Full	Load Profile	Water Volume	ERP Energy Rating	Energy Efficiency	Reheat Time Indirect	Standing Loss	Annual Energy Usage	Primary Coil Rating	Solar Coil Rating
210	TRSMVG30210LFC	Direct	41	251	L	210	C	36		62	2862		
	TRSMVD-0210LFC	Indirect	45	248		210	B		32.5	62		18.15	
	TRSMVI-0210LFC	Direct Slimline	41	251	M	210	C	33		68	1502		
	TRSMVD-0210SFC	Indirect Slimline	42	255		210	C		32.05	68		18.15	
	TRSMVH-0210LFC	High Gain Indirect	58	261		210	B		12.87	62			
	TRSMVH-0210SFC	Slim High Gain Ind	48	230		210	C						
	TRSMVI-0210SFC	Horizontal Indirect	45	250		210	C		27.24	80		17.58	
TRSMHI-0210LFC	Solar Twin	48	250		210	C		23.7	62		18.15	17.18	
210 AIR	TRIMVD-0210LFC	Direct Air	41	232	L	191	C	37		58	2796		
	TRIMVI-0210LFC	Indirect Air	45	232		210	B		29.06	58		14.91	
	TRIMVD-0210SFC	Direct Slimline Air	41	244	L	183	C	37		70	2840		
	TRIMVI-0210SFC	Indirect Slimline Air	45	232		210	B		23.9	69		19.15	
	TRIMVS-0210LFC	Solar Twin Air	48	232		184	B		37	58		15.34	13.68
250	TRSMVG30250LFC	Direct	46	296	XL	250	C	35		73	2920		
	TRSMVD-0250LFC	Indirect	51	296		250	C		38.83	73		17.8	
	TRSMVH-0250LFC	High Gain Indirect	51	296		250	C		16.93	73			
	TRSMVI-0250LFC	Horizontal Indirect	51	296		250	C		31.64	89		18.07	
	TRSMHI-0250LFC	Solar Twin	53	294		250	C		26.33	73		17.8	19
	TRIMVD-0250LFC	Direct Air	46	281	XL	235	C	38		60	4577		
250 AIR	TRIMVI-0250LFC	Indirect Air	51	281		250	C		32.88	60		17.7	
	TRIMVS-0250LFC	Solar Twin Air	53	279		226	B		40	60		17.41	14.78
300	TRSMVD-0300LFC	Direct	55	355	XL	300	C	35		85	2920		
	TRSMVI-0300LFC	Indirect	60	355		300	C		43.8	85		19.35	
	TRSMVH-0300LFC	High Gain Indirect	63	356		300	C		21.26	85			
	TRSMHI-0300LFC	Horizontal Indirect	60	355		300	C		36.05	98		18.56	
	TRIMVS-0300LFC	Solar Twin	63	353		300	C		29.3	85		19.35	20.87
300 AIR	TRIMVD-0300LFC	Direct Air	55	319	XL	264	C	38		75	4677		
	TRIMVI-0300LFC	Indirect Air	60	319		300	C		37.8	75		0.2	
	TRIMVS-0300LFC	Solar Twin Air	63	317		254	C		41	75		0.2	16.73

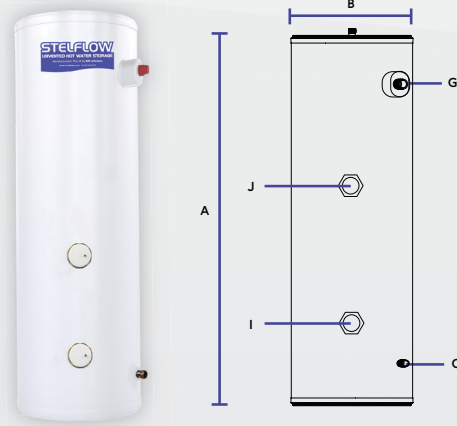

Direct

		A	B	C	G	I	J
		HEIGHT	DIAMETER	COLD WATER INLET	T&P RELIEF VALVE	IMMERSION HEATER BOTTOM	IMMERSION HEATER TOP
120	TRSMVD-0150LFB	900	545	195	703	242	519
150	TRSMVD-0180LFB	1100	545	195	890	242	619
180	TRSMVD-0210LFC	1280	545	195	1078	242	719
210	TRSMVD-0250LFC	1470	545	195	1266	242	819
250	TRSMVD-0300LFC	1720	545	195	1516	242	959
300	TRSMVD-0300LFC	1980	545	195	1829	242	1109

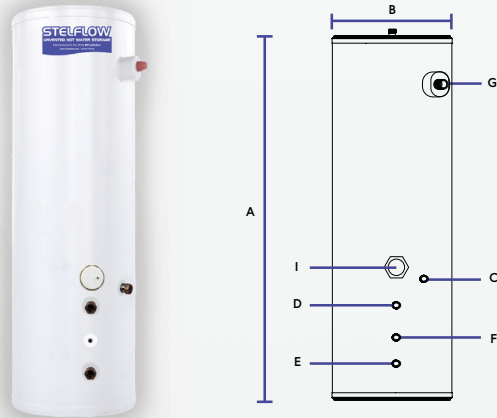

Indirect

		A	B	C	D	E	F	G	I	K
		HEIGHT	DIAMETER	COLD WATER INLET	PRIMARY COIL FLOW	PRIMARY COIL RETURN	AQUASTAT POCKET BOTTOM	T&P RELIEF VALVE	IMMERSION HEATER BOTTOM	SECONDARY RETURN
120	TRSMVI-0120LFB	900	545	480	440	200	387	710	686	
150	TRSMVI-0150LFB	1100	545	560	520	200	387	890	670	
180	TRSMVI-0180LFB	1280	545	600	560	200	392	1085	710	
210	TRSMVI-0210LFC	1470	545	640	600	200	467	1265	750	1160
250	TRSMVI-0250LFC	1720	545	640	600	200	467	1520	750	1410
300	TRSMVI-0300LFC	1980	545	640	600	200	467	1785	750	1605

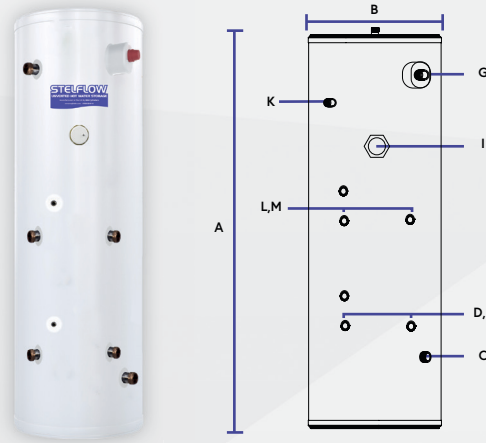

Twin Solar

		A	B	C	D	E	F	G	I	K	L	M	N
		HEIGHT	DIAMETER	COLD WATER INLET	LOWER COIL FLOW	LOWER COIL RETURN	AQUASTAT POCKET BOTTOM	T&P RELIEF VALVE	IMMERSION HEATER BOTTOM	SECONDARY RETURN	UPPER COIL FLOW	UPPER COIL RETURN	SOLAR SENSOR
150	TRSMVS-0150LFB	1140	545	195	310	310	705	900	390		660	660	900
180	TRSMVS-0180LFB	1320	545	195	310	310	725	1070	460		665	665	1070
210	TRSMVS-0210LFC	1510	545	195	370	370	835	1265	525	1155	780	780	1265
250	TRSMVS-0250LFC	1760	545	195	370	370	905	1510	680	1400	855	855	1510
300	TRSMVS-0300LFC	1980	545	195	370	370	1035	1785	785	1615	990	990	1785

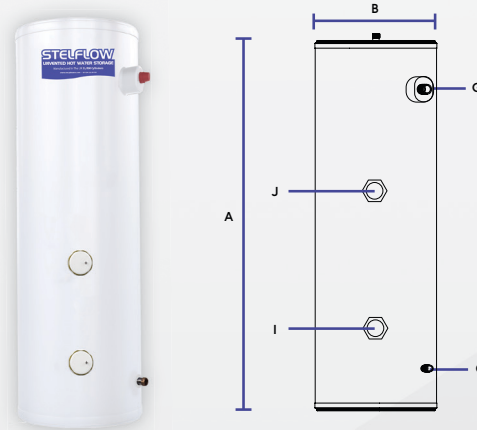

Slimline Direct

		A	B	C	G	I	J
		HEIGHT	DIAMETER	COLD WATER INLET	T&P RELIEF VALVE	IMMERSION HEATER BOTTOM	IMMERSION HEATER TOP
120	TRSMVD-0120SFC	1205	475	162	987	212	722
150	TRSMVD-0150SFC	1470	475	162	1262	212	905
180	TRSMVD-0180SFC	1750	475	162	1527	212	1082
210	TRSMVD-0210SFC	1920	475	162	1739	212	1245

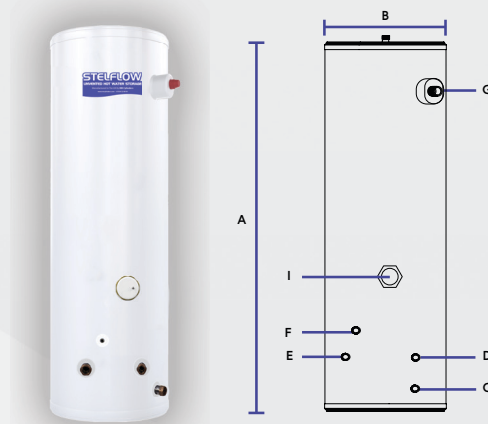

Slimline Indirect

		A	B	C	D	E	F	G	I
		HEIGHT	DIAMETER	COLD WATER INLET	PRIMARY COIL FLOW	PRIMARY COIL RETURN	AQUASTAT POCKET BOTTOM	T&P RELIEF VALVE	IMMERSION HEATER BOTTOM
120	TRSMVI-0120SFC	1266	475		288	288	343	722	328
150	TRSMVI-0150SFC	1205	475	162	288	288	393	987	368
180	TRSMVI-0180SFC	1470	475	162	328	328	433	1262	418
210	TRSMVI-0210SFC	1750	475		328	328	433	1527	418

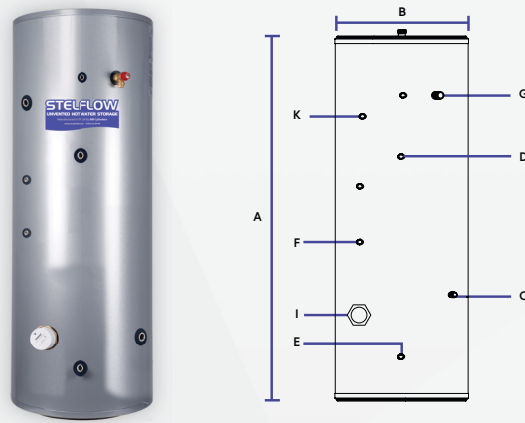

High Gain Indirect

		A	B	C	D	E	F	G	H	I	K
		HEIGHT	DIAMETER	COLD WATER INLET	PRIMARY COIL FLOW	PRIMARY COIL RETURN	AQUASTAT POCKET	T&P RELIEF VALVE	HOT WATER CONNECTION	IMMERSION HEATER BOTTOM	SECONDRY RETURN
180	TRSMVH-0180LFB	1310	540	346	806	196	420	1030	1310	346	881
210	TRSMVH-0210LFC	1490	540	346	946	196	420	1211	1490	346	981
250	TRSMVH-0250LFC	1815	540	346	1046	196	450	1531	1815	346	1271
300	TRSMVH-0300LFC	1600	600	368	1018	218	450	1333	1600	368	1153

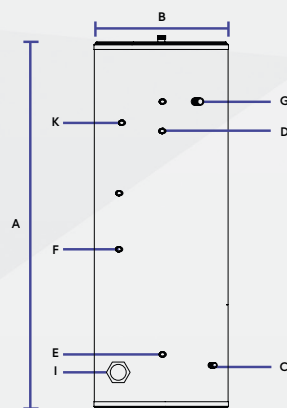

Slim High Gain Indirect

		A	B	C	D	E	F	G	H	I	K
		HEIGHT	DIAMETER	COLD WATER INLET	PRIMARY COIL FLOW	PRIMARY COIL RETURN	AQUASTAT POCKET	T&P RELIEF VALVE	HOT WATER CONNECTION	IMMERSION HEATER BOTTOM	SECONDRY RETURN
180	TTUMVH-0180SFC	1550	475	191	1081	261	534	1301	1550	211	1101
210	TTUMVH-0210SFC	1840	475	191	1076	256	466	1601	1840	206	1351



Horizontal Indirect

Capacity	120L	150L	180L	210L	250L	300L
Code	TTUMHI-0120LFB	TTUMHI-0150LFB	TTUMHI-0180LFB	TTUMHI-0210LFC	TTUMHI-0250LFC	TTUMHI-0300LFC
Length (A)	900	1100	1280	1470	1720	1980
Diameter (B)	545	545	545	545	545	545
Weight (empty)	30	38	42	45	51	60
Weight (full)	146	184	218	250	296	355
Hot water volume	120	150	180	210	250	300
Energy Efficiency Class	C	C	C	C	C	C
Heat up Time - coil (Mins)	15.82	20.58	22.43	27.24	31.64	36.05
Standing Loss (W)	54	63	71	80	89	98

Direct

		A	B	C	G	I	J
		HEIGHT	DIAMETER	COLD WATER INLET	T&P RELIEF VALVE	IMMERSION HEATER BOTTOM	IMMERSION HEATER TOP
180	TRIMVD-0180LFB	1324	545	190	848	210	670
210	TRIMVD-0210LFC	1511	545	190	982	210	755
250	TRIMVD-0250LFC	1762	545	190	1160	210	875
300	TRIMVD-0300LFC	1986	545	190	1323	210	980

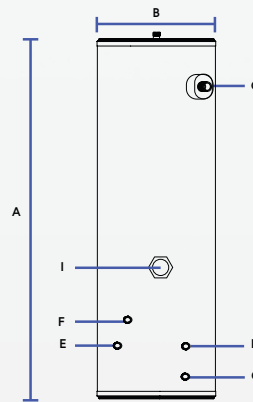
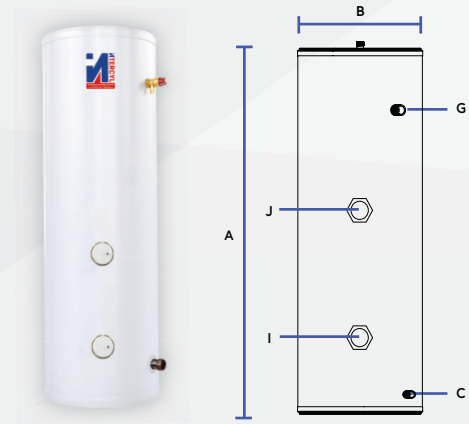

Indirect

		A	B	C	D	E	F	G	I	I	K
		HEIGHT	DIAMETER	COLD WATER INLET	PRIMARY COIL FLOW	PRIMARY COIL RETURN	AQUASTAT POCKET BOTTOM	T&P RELIEF VALVE	IMMERSION HEATER BOTTOM	IMMERSION HEATER TOP	SECONDRY RETURN
150	TRIMVI-0150LFB	1140	545	190	298	298	368	715	670	348	
180	TRIMVI-0180LFB	1324	545	190	338	338	408	848	710	388	
210	TRIMVI-0210LFC	1511	545	190	373	373	443	982	750	423	882
250	TRIMVI-0250LFC	1762	545	190	373	373	443	1160	750	423	1060
300	TRIMVI-0300LFC	1986	545	190	373	373	443	1323	750	423	1223

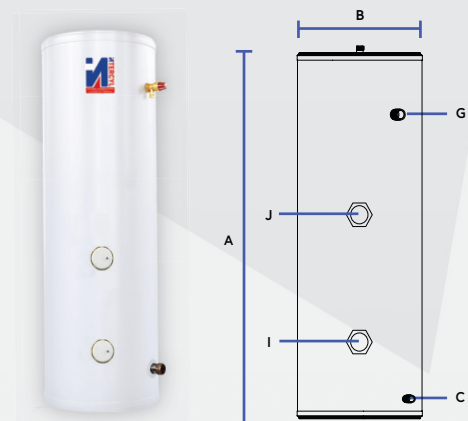

Slim Direct

		A	B	C	G	I	I
		HEIGHT	DIAMETER	COLD WATER INLET	T&P RELIEF VALVE	IMMERSION HEATER BOTTOM	IMMERSION HEATER BOTTOM
150	TRIMVD-0150SFB	1478	475	162	970	182	727
180	TRIMVD-0180SFB	1743	475	162	1158	182	845
210	TRIMVD-0210SFC	1955	475	162	1292	182	947

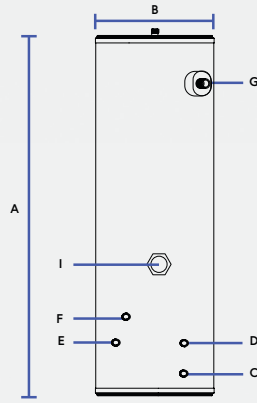

Slim Indirect

		A	B	C	D	E	F	G	I
		HEIGHT	DIAMETER	COLD WATER INLET	PRIMARY COIL FLOW	PRIMARY COIL RETURN	AQUASTAT POCKET BOTTOM	T&P RELIEF VALVE	IMMERSION HEATER BOTTOM
150	TRIMVI-0150SFB	1478	475	162	328	328	428	970	408
180	TRIMVI-0180SFB	1743	475	162	328	328	428	1158	408
210	TRIMVI-0210SFC	1955	475	162	328	328	428	1292	408

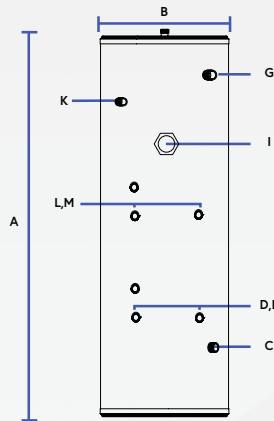

Twin Solar

		A	B	C	D	E	F	G	J	K	L	M	N
		HEIGHT	DIAMETER	COLD WATER INLET	LOWER COIL FLOW	LOWER COIL RETURN	AQUASTAT POCKET BOTTOM	T&P RELIEF VALVE	IMMERSION HEATER TOP	SECONDRY RETURN	UPPER COIL FLOW	UPPER COIL RETURN	SOLAR SENSOR
180	TRIMVS-0180LFB	1324	545	190	298	298	353	848	683		633	633	848
210	TRIMVS-0210LFC	1511	545	190	338	338	393	982	738	882	688	688	982
250	TRIMVS-0250LFC	1762	545	190	373	373	428	1160	912	1060	862	862	1160
300	TRIMVS-0300LFC	1986	545	190	373	373	428	1323	943	1223	932	932	1323

RM Stelflow Pre-Plumb Unit...

MAKING INSTALLATION A WHOLE LOT EASIER

The RM Stelflow unit is available in an upgraded plug and go pre-plumbed format. This is available right across our range of units including Slimline, Twin Coil, and Horizontal cylinders. This makes installation quicker and easier saving the contractor both time and money. We can also guarantee our workmanship as we have in place stringent quality checks to make sure the units arrive leak free and ready to go. All units are assembled in our premises and over seen by qualified plumbers.

Selection Guide

			KG	KG	L		MINS	W	KW	KW	BAR	L
			Weight Empty	Weight Full	Water Volume	ERP Energy Rating	Reheat Time Indirect	Standing Loss	Primary Coil Surface Area	Primary Coil Rating	Primary Coil Resistance	Primary Coil Fluid Volume
120	TRTI-S0120-L1C	System Ready Single Zone	30	146.39	120	B	19.05	46	0.656	15.63	0.2	3.61
	TRTI-H0120-L1C	System Fit Single Zone	30	146.39	120	B	19.05	46	0.656	15.63	0.2	3.61
	TRTI-S0120-L2C	System Ready Twin Zone	30	146.39	120	B	19.05	46	0.656	15.63	0.2	3.61
150	TRTI-S0150-L1C	System Ready Single Zone	38	184.39	150	B	23.71	53	0.76	16.33	0.2	4.18
	TRTI-S0150-L2C	System Ready Twin Zone	38	184.39	150	B	23.71	53	0.76	16.33	0.2	4.18
	TRTI-H0150-L1C	System Fit Single Zone	38	184.39	150	B	23.71	53	0.76	16.33	0.2	4.18
	TRTI-H0150-L2C	System Fit Twin Zone	38	184.39	150	B	23.71	53	0.76	16.33	0.2	4.18
180	TRTI-S0180-L1C	System Ready Single Zone	42	217.86	180	B	29.2	58	0.76	15.9	0.2	4.18
	TRTI-S0180-L2C	System Ready Twin Zone	42	217.86	180	B	29.2	58	0.76	15.9	0.2	4.18
	TRTI-H0180-L1C	System Fit Single Zone	42	217.86	180	B	29.2	58	0.76	15.9	0.2	4.18
	TRTI-H0180-L2C	System Fit Twin Zone	42	217.86	180	B	29.2	58	0.76	15.9	0.2	4.18
210	TRTI-S0210-L1C	System Ready Single Zone	45	248.25	210	B	32.5	62	0.76	18.15	0.2	4.18
	TRTI-S0210-L2C	System Ready Twin Zone	45	248.25	210	B	32.5	62	0.76	18.15	0.2	4.18
	TRTI-H0210-L1C	System Fit Single Zone	45	248.25	210	B	32.5	62	0.76	18.15	0.2	4.18
	TRTI-H0210-L2C	System Fit Twin Zone	45	248.25	210	B	32.5	62	0.76	18.15	0.2	4.18
250	TRTI-S0250-L1C	System Ready Single Zone	51	296.25	250	C	38.83	73	0.878	17.8	0.2	4.75
	TRTI-S0250-L2C	System Ready Twin Zone	51	296.25	250	C	38.83	73	0.878	17.8	0.2	4.75
	TRTI-H0250-L1C	System Fit Single Zone	51	296.25	250	C	38.83	73	0.878	17.8	0.2	4.75
	TRTI-H0250-L2C	System Fit Twin Zone	51	296.25	250	C	38.83	73	0.878	17.8	0.2	4.75
300	TRTI-S0300-L1C	System Ready Single Zone	60	355.25	300	C	43.8	85	0.878	19.35	0.2	4.75
	TRTI-S0300-L2C	System Ready Twin Zone	60	355.25	300	C	43.8	85	0.878	19.35	0.2	4.75
	TRTI-H0300-L1C	System Fit Single Zone	60	355.25	300	C	43.8	85	0.878	19.35	0.2	4.75
	TRTI-H0300-L2C	System Fit Twin Zone	60	355.25	300	C	43.8	85	0.878	19.35	0.2	4.75

Kit Contents

Item No.	Description	QTY	System Fit	System Ready
TZM-I-PPM022MM	Two port motorised valve	2	✓	✓
TZW-WC00000000	PCB wiring centre	1	✓	✓
TZC-D-ESI-0000	ESI Smart dual cylinder thermostat	1	✓	✓
HZC-215-A25-60	Wilco 6m head circulator	1	✓	
TZ-V-BMANIFOLD	Auto bypass	1	✓	✓
TZ-MANUALV-0.5	Auto air vent	1	✓	✓
TZ-G-0-0000UKZ	Sealed system filling loop	1	✓	
TZG-P-0-000AC6	Inlet group control set C/W Pressure relief valve	1	✓	✓
TZ9-7.0-0000.5	Temperature and pressure relief valve	1	✓	✓
TV-P0-0000012L	120-210ltr – 12ltr Exp	1	✓	✓
TV-P0-0000019L	250 ltr – 19ltr Exp			
TV-P0-0000019L	300ltr – 24ltr Exp			

Item No.	Description	QTY	System Fit	System Ready
UZT-ESI0000002	ESI 2 Channel programmer	1	✓	✓
TZC-5-ESILPROG	ESI Room thermostat	1	✓	✓
TI-I-Q-14-3-01	3kW 1 Phase Immersion element	1	✓	✓
TZU-000015X022	15mm – 22mm Tundish	1	✓	✓
TZ9-TPV-00-COV	Temperature and pressure relief valve cover	1	✓	✓
HMPYK-00000012	12L Robokit sealed system Kit + Br	1	✓	
HMPYK-00000018	18L Robokit sealed system Kit + Br	1	✓	
HMPYK-00000024	24L Robokit sealed system Kit + Br	1	✓	

System Ready Single Zone

		A	B	C	G	Q	S	T	U
		HEIGHT	DIAMETER	COLD WATER INLET	T&P RELIEF VALVE	ZONE 1 FLOW	ZONE RETURN	BOILER FLOW	BOILER RETURN
120	TRTI-S0120-L1C	900	545						
150	TRTI-S0150-L1C	1100	545						
180	TRTI-S0180-L1C	1280	545	1255	903	680	205	395	235
210	TRTI-S0210-L1C	1470	545	1443	1090	720	245	434	275
250	TRTI-S0250-L1C	1720	545	1695	1340	720	243	438	273
300	TRTI-S0300-L1C	1980	545	1910	1570	730	250	450	280

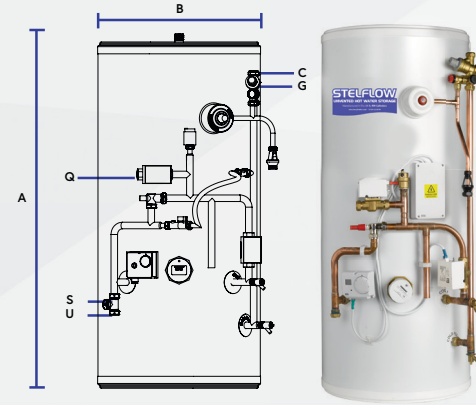

STELFLOW CYLINDERS

System Ready Twin Zone

		A	B	C	G	Q	R	S	
		HEIGHT	DIAMETER	COLD WATER INLET	T&P RELIEF VALVE	ZONE 1 FLOW	ZONE 2 FLOW	ZONE RETURN	
120	TRTI-S0120-L2C	900	545						
150	TRTI-S0150-L2C	1100	545						
180	TRTI-S0180-L2C	1280	545	1255	903	680	820	205	395
210	TRTI-S0210-L2C	1470	545	1443	1090	720	854	245	434
250	TRTI-S0250-L2C	1720	545	1695	1340	720	854	243	438
300	TRTI-S0300-L2C	1980	545	1910	1570	730	865	250	450

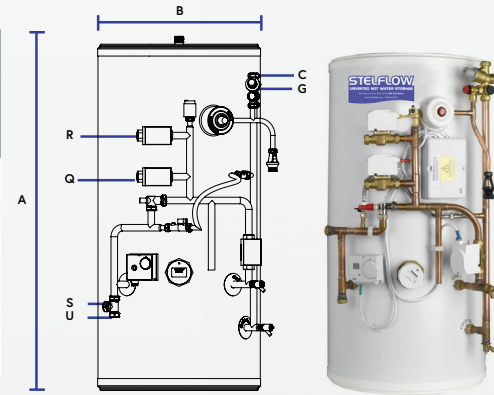

System Fit Single Zone

		A	B	C	G	Q	R	S	T	U
		HEIGHT	DIAMETER	COLD WATER INLET	T&P RELIEF VALVE	ZONE 1 FLOW	ZONE 2 FLOW	ZONE RETURN	BOILER FLOW	BOILER RETURN
120	TRTI-H0120-L1C	900	545							
150	TRTI-H0150-L1C	1100	545							
180	TRTI-H0180-L1C	1280	545	1255	903	680	820	205	395	235
210	TRTI-H0210-L1C	1470	545	1443	1090	720	854	245	434	275
250	TRTI-H0250-L1C	1720	545	1695	1340	720	854	243	438	273
300	TRTI-H0300-L1C	1980	545	1910	1570	730	865	250	450	280

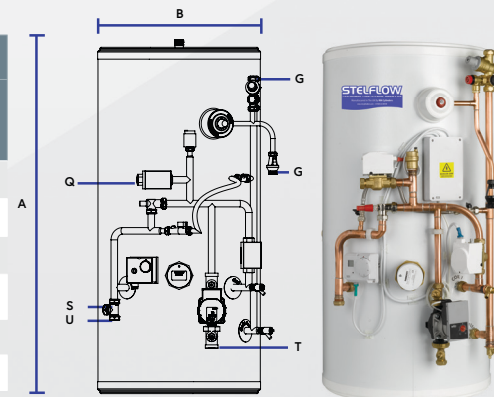

System Fit Twin Zone

		A	B	C	G	Q	S	T	U
		HEIGHT	DIAMETER	COLD WATER INLET	T&P RELIEF VALVE	ZONE 1 FLOW	ZONE RETURN	BOILER FLOW	BOILER RETURN
150	TRTI-H0150-L2C	1100	545	1255	903	680	205	395	235
180	TRTI-H0180-L2C	1280	545	1443	1090	720	245	434	275
210	TRTI-H0210-L2C	1470	545	1695	1340	720	243	438	273
250	TRTI-H0250-L2C	1720	545	1910	1570	730	250	450	280
300	TRTI-H0300-L2C	1980	545						

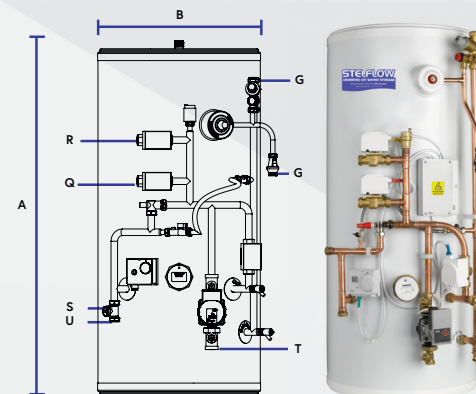

Commercial Cylinder Quick Guide

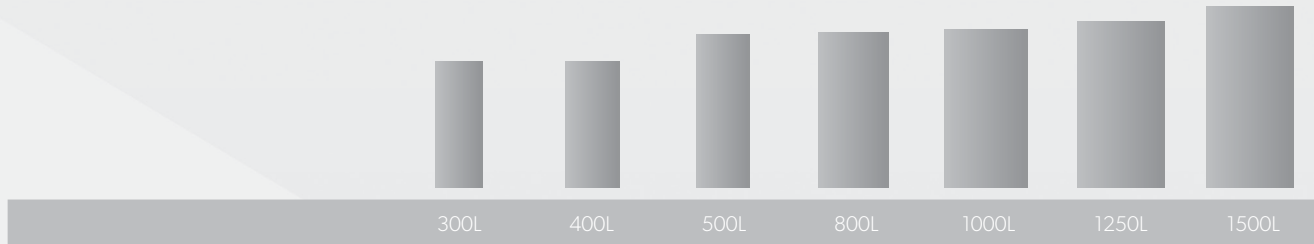

Commercial 3 & 6 bar models	Multi Energy	300L	400L	500L	800L	1000L	1250L	1500L
Indirect								
Solar								

All Cylinders - 3 & 6bar	300	400	500	800	1000	1250	1500
Diameter (mm)	620	710	710	920	1100	1150	1150
Height (mm)	1670	1670	2030	2050	2170	2200	2400
Hot And Cold Connections BSP F	1.5"	1.5"	1.5"	2.0"	2.0"	2.0"	2.0"
Coil Conn. (+for the solar coil) BSP F	1.5"	1.5"	1.5"	1.5"	1.5"	1.5"	1.5"
Secondary Return BSP F	1.25"	1.25"	1.25"	1.25"	1.25"	1.5"	1.5"
Max. Op. Pressure - 3/6 bar kit (bar)	6 / 10	6 / 10	6 / 10	6 / 10	6 / 10	6 / 10	6 / 10
T&P Setting 3/6 bar kit (bar)	7 / 10	7 / 10	7 / 10	7 / 10	7 / 10	7 / 10	7 / 10
T&P Size - Multi Energy / Indirect+Solar	1.0" / 0.75"	1.0" / 0.75"	1.0" / 0.75"	1.0" / 0.75"	1.25" / 0.75"	1.25" / 1.25"	1.25" / 1.25"
Cold W. Safety Devices - PRV, ERV, Chk Vlv	1.0" (one piece)		1.25" (multi piece)		1.5" (multi piece)		
Exp. Relief Valve Setting - 3/6 bar kit (bar)	6 / 8	6 / 8	6 / 8	6 / 8	6 / 8	6 / 8	6 / 8
2-port Mot. Valve (Indirect&Solar Only)	28mm	28mm	28mm	28mm	1.25"	1.5"	1.5"
2-port Mot. Valve Conn. (Ind & Sol Only)	Compression nut and olive			Pipe union conn. nut and tail piece			
Expansion Vessel Size - 3/6 bar kit (ltr)	24 / 35	35 / 50	50 / 80	80 / 100	100 / 150	150 / 200	150 / 200
Tundish	1.25"	1.25"	1.25"	1.25"	1.5"	1.5"	1.5"
ErP Energy Efficiency Class	C	C	C	C	C	C	C
Standing Loss (W)	92	102	115	121	124	135	160

Multi Energy Only	300	400	500	800	1000	1250	1500
Titanium Imm. - Fact. Fitted As Std.	3 x 6kW	3 x 6kW	3 x 6kW	3 x 6kW	2 x 6kW	2 x 6kW	2 x 6kW
No. Of Imm Heater Bosses In Total	4x Screw			3x Screw + 1x Flange			
Maximum Energy Input Permitted (kW)	48	48	48	48	78	78	78
Imm. Heaters - Opt. Higher Rated Elements	See page 17 for further details						
Inspection Flange	Optional - CANNOT be used for flanged imm. heaters				Supplied as std - CAN be used for fl. imm.		
Heat Up Time T 50°C	Reheat time in mins = Litres x 3.2 / kW installed						

Indirect Only	300	400	500	800	1000	1250	1500
Titanium Imm. - Fact. Fitted As Std.	2 x 3kW	2 x 3kW	2 x 3kW	2 x 3kW	2 x 3kW	2 x 3kW	2 x 3kW
Coil Surface Area (m ²)	1.54	1.97	1.97	2.86	2.86	4.73	4.73
Coil Diameter (mm)	32	32	32	38	38	38	38
Coil Rating @60L/min 80°C (kW)	49	57	57	73	73	98	98
Coil - Maximum Pressure (bar)	6	6	6	6	6	6	6
Inspection Flange	Optional - for inspection only - CANNOT be used with flanged immersion heaters						

Solar Only	300	400	500	800	1000	1250	1500
Titanium Imm. - Fact. Fitted As Std.	2 x 3kW	2 x 3kW	2 x 3kW	2 x 3kW	2 x 3kW	2 x 3kW	2 x 3kW
Primary Couil Surface Area (m ²)	1.21	1.21	1.21	2.86	2.86	4	4
Prim. Coil Rating @ 60L/m 80°C (kW)	46	46	46	73	73	95	95
Coils (Prim & Solar) - Max. Pressure (bar)	6	6	6	6	6	6	6
Dedicated Solar Volume (ltr)	113.1	153.3	197.9	307.9	460.8	499.0	483.0
Solar Coil Surface Area (m ²)	1.1	1.1	1.1	2.0	2.0	2.5	2.5
Coil Diameter (Both Coils)	32	32	32	38	38	38	38
Solar Coil Rating @ 60L/m (kW)	43	43	43	57	57	68	68
Inspection Flange	Optional - for inspection only - CANNOT be used with flanged immersion heaters						

Indirect Commercial



COMMERCIAL

Connection Sizes & Safety		300	400	500	800	1000	1250	1500
Hot & Cold Conn. Ø BSP F (")		1.5	1.5	1.5	2	2	2	2
Coil Connection Ø BSP F (")		1.5	1.5	1.5	1.5	1.5	1.5	1.5
Secondary Return Ø BSP F (")		1.25	1.25	1.25	1.25	1.25	1.5	1.5
T&P Connection Ø BSP F (")		0.75	0.75	0.75	0.75	1	1	1
3 bar	T&P Press. Set. (bar)	7	7	7	7	7	7	7
	Exp. Relief Set. (bar)	6	6	6	6	6	6	6
6 bar	T&P Press. Set. (bar)	10	10	10	10	10	10	10
	Exp. Relief Set. (bar)	8	8	8	8	8	8	8

300 - 800 Ltr

1000 - 1500 Ltr

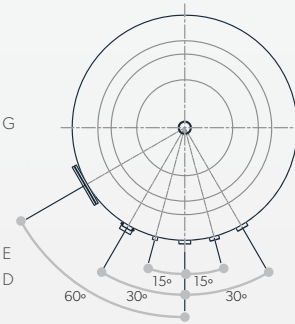
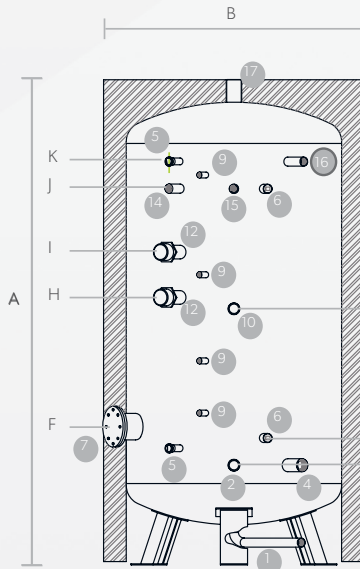
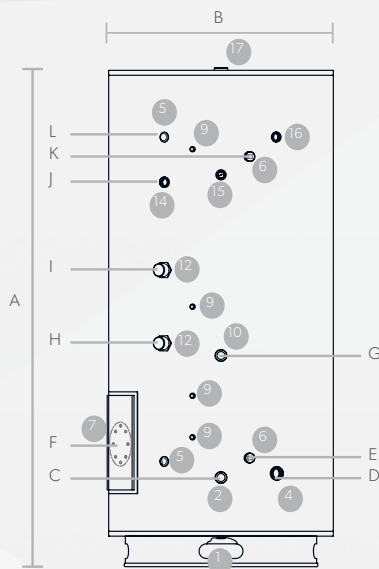

- 1 Drain
- 2 Boiler Return
- 4 Cold Water Inlet
- 5 Temperature Gauge (fact. fitted)
- 6 Heat Source F&R / D-strat (28mm)
- 7 Inspection Hatch c/w Plastic Cover (optional)
- 8 Dry Sensor Pocket
- 9 Aquastat Pocket
- 10 Boiler Flow
- 12 Titanium Immersion (fact. fitted)
- 14 Secondary Return
- 15 Pressure Gauge
- 16 T&P Relief Valve
- 17 Hot Water Draw Off

Dimensions	300	400	500	800	1000	1250	1500
Cylinder Height A (mm)	1670	1670	2030	2050	2170	2200	2400
Cylinder Diameter B (mm)	620	710	710	920	1100	1150	1150
Connection Height C (mm)	325	340	340	395	900	950	950
Connection Height D (mm)	335	350	350	415	425	410	360
Connection Height E (mm)	475	440	440	520	525	530	480
Connection Height F (mm)	500	490	490	560	580	580	530
Connection Height G (mm)	765	750	960	890	860	1010	980
Connection Height H (mm)	815	800	1010	955	930	1060	1040
Connection Height I (mm)	995	980	1200	1255	1235	1260	1260
Connection Height J (mm)	1175	1190	1550	1590	1565	1630	1830
Connection Height K (mm)	1285	1300	1660	1695	1700	1755	1950
Connection Height L (mm)	1430	1390	1750	1785	1798	-	-



Inspection port must be ordered separately. Only standard on Multi Energy cylinders 1000L and over capacity.

ErP	300	400	500	800	1000	1250	1500
Storage volume V in ltr	283	379	485	747	1079	1201	1350
Standing Loss (W)	92	102	115	121	124	135	160
Energy Efficiency Class	C	C	C	C	C	C	C

* Primary flow rates at 30L/m are based on a flow temperature of 80°C ± 2°C. Testing is carried out to BS EN12897:2006

For information on Immersion Heater options see page 87.

Multi Energy Commercial



Connection Sizes & Safety	300	400	500	800	1000	1250	1500
Hot & Cold Conn. Ø BSP F (")	1.5	1.5	1.5	2	2	2	2
Coil Connection Ø BSP F (")	1.5	1.5	1.5	1.5	1.5	1.5	1.5
Secondary Return Ø BSP F (")	1.25	1.25	1.25	1.25	1.25	1.5	1.5
T&P Connection Ø BSP F (")	1	1	1	1	1.25	1.25	1.25
3 bar							
T&P Press. Set. (bar)	7	7	7	7	7	7	7
Exp. Relief Set. (bar)	6	6	6	6	6	6	6
6 bar							
T&P Press. Set. (bar)	10	10	10	10	10	10	10
Exp. Relief Set. (bar)	8	8	8	8	8	8	8

300 - 800 Ltr

1000 - 1500 Ltr

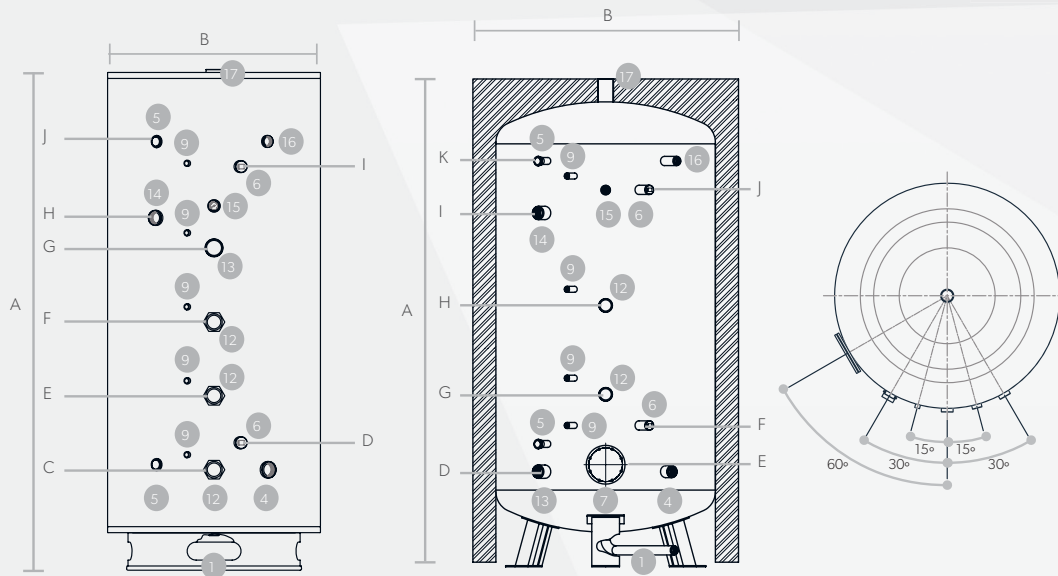

- 1 Drain
- 2 Boiler Return
- 4 Cold Water Inlet
- 5 Temperature Gauge (fact. fitted)
- 6 Heat Source F&R / D-strat (28mm)
- 7 Inspection Hatch c/w Plastic Cover
- 8 Dry Sensor Pocket
- 9 Aquastat Pocket
- 10 Boiler Flow
- 12 Titanium Immersion (fact. fitted)
- 13 Immersion Boss (blanked)
- 14 Secondary Return
- 15 Pressure Gauge
- 16 T&P Relief Valve
- 17 Hot Water Draw Off

Dimensions	300	400	500	800	1000	1250	1500
Cylinder Height A (mm)	1670	1670	2030	2050	2170	2200	2400
Cylinder Diameter B (mm)	620	710	710	920	1100	1150	1150
Connection Height C (mm)	335	350	350	445	900	950	950
Connection Height D (mm)	425	440	440	570	515	410	410
Connection Height E (mm)	580	590	665	760	625	440	440
Connection Height F (mm)	830	830	975	1070	845	550	550
Connection Height G (mm)	1075	1090	1290	1385	1215	745	745
Connection Height H (mm)	1175	1190	1550	1640	1615	1130	1255
Connection Height I (mm)	1350	1300	1660	1745	1750	1530	1780
Connection Height J (mm)	1430	1390	1750	1845	1850	1630	1880
Connection Height K (mm)	-	-	-	-	-	1755	2005



Inspection port must be ordered separately. Only standard on Multi Energy cylinders 1000L and over capacity.

ErP	300	400	500	800	1000	1250	1500
Storage volume V in ltr	289.5	391	497	766	1097	1231	1410
Standing Loss (W)	92	102	115	121	124	135	160
Energy Efficiency Class	C	C	C	C	C	C	C

Solar Commercial



COMMERCIAL

Connection Sizes & Safety	300	400	500	800	1000	1250	1500
Hot & Cold Conn. Ø BSP F (")	1.5	1.5	1.5	2	2	2	2
Prim. Coil Conn. Ø BSP F (")	1.5	1.5	1.5	1.5	1.5	1.5	1.5
Solar Coil Conn. Ø BSP F (")	1	1	1	1	1	1	1
Secondary Return Ø BSP F (")	1.25	1.25	1.25	1.25	1.25	1.5	1.5
T&P Connection Ø BSP F (")	0.75	0.75	0.75	0.75	0.75	1	1
3 bar T&P Press. Set. (bar)	7	7	7	7	7	7	7
3 bar Exp. Relief Set. (bar)	6	6	6	6	6	6	6
6 bar T&P Press. Set. (bar)	10	10	10	10	10	10	10
6 bar Exp. Relief Set. (bar)	8	8	8	8	8	8	8

300 - 800 Ltr

1000 - 1500 Ltr

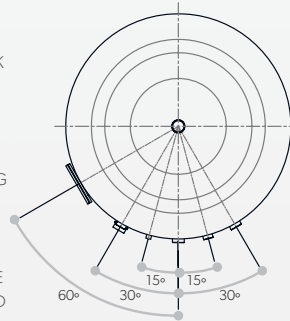
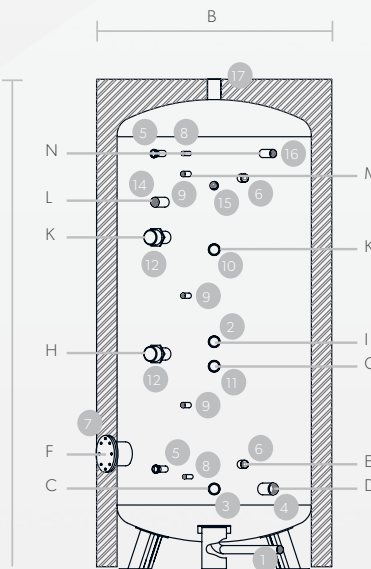
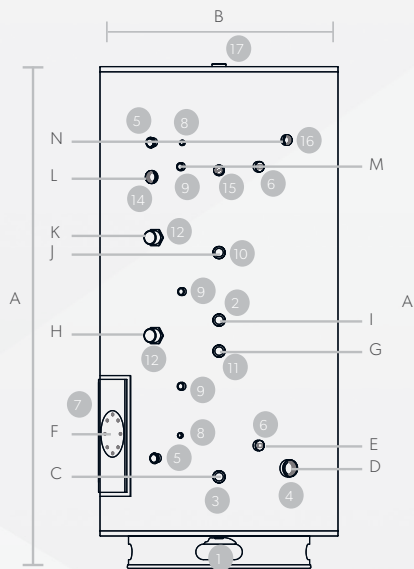

- 1 Drain
- 2 Boiler Return
- 3 Solar Return
- 4 Cold Water Inlet
- 5 Temperature Gauge (fact. fitted)
- 6 Heat Source F&R / D-strat (28mm)
- 7 Inspection Hatch c/w Plastic Cover (optional)
- 8 Dry Sensor Pocket
- 9 Aquastat Pocket
- 10 Boiler Flow
- 11 Solar Flow
- 12 Titanium Immersion (fact. fitted)
- 14 Secondary Return
- 15 Pressure Gauge
- 16 T&P Relief Valve
- 17 Hot Water Draw Off

Dimensions	300	400	500	800	1000	1250	1500
Cylinder Height A (mm)	1670	1670	2030	2050	2170	2200	2400
Cylinder Diameter B (mm)	620	710	710	920	1100	1150	1150
Connection Height C (mm)	335	350	350	395	900	950	950
Connection Height D (mm)	335	350	350	420	425	410	410
Connection Height E (mm)	425	440	440	515	525	530	530
Connection Height F (mm)	475	490	490	560	580	580	580
Connection Height G (mm)	665	670	800	845	850	820	1050
Connection Height H (mm)	715	720	860	905	910	880	1110
Connection Height I (mm)	765	770	920	965	970	940	1170
Connection Height J (mm)	1145	1095	1300	1345	1350	1320	1550
Connection Height K (mm)	1195	1145	1360	1405	1410	1380	1610
Connection Height L (mm)	1305	1245	1550	1505	1560	1580	1810
Connection Height M (mm)	1340	1300	1660	1550	1700	1630	1890
Connection Height N (mm)	1430	1390	1730	1655	1800	1750	2010



Inspection port must be ordered separately. Only standard on Multi Energy cylinders 1000L and over capacity.

ErP	300	400	500	800	1000	1250	1500
Storage volume V in ltr	278.5	377	483	732	1063	1185	1350
Standing Loss (W)	92	102	115	121	124	135	160
Energy Efficiency Class	C	C	C	C	C	C	C

Ordering Guide - Commercial

Commercial Indirect - 3bar

Product	300	400	500	800	1000	1250	1500
Cylinder Height (A, mm)	1670	1670	2030	2050	2090	2200	2400
Cylinder Diameter (B, mm)	620	710	710	920	1100	1150	1150
Weight Empty (kg)	82	87	104	220	230	235	267
Weight Full (kg)	365	466	589	967	1309	1436	1617
ErP Rating	C	C	C	C	C	C	C
Cylinder Ordering Code	TCFM- VI-0300NFC	TCFM- VI-0400LFC	TCFM- VI-0500LFC	TCFM- VI-0800LFC	TCFM- VI-1000LFC	TCFM- VI-1250LFC	TCFM- VI-1500LFC
Unvented Kit Ordering Code	Inc.	Inc.	Inc.	TYN-32-03- 080L	TYN-32-03- 100L	Inc.	Inc.

Commercial Indirect - 6bar

Product	300	400	500	800	1000	1250	1500
Cylinder Height (A, mm)	1670	1670	2030	2050	2090	2200	2400
Cylinder Diameter (B, mm)	620	710	710	920	1100	1150	1150
Weight Empty (kg)	82	87	104	220	230	235	267
Weight Full (kg)	365	466	589	967	1309	1436	1617
ErP Rating	C	C	C	C	C	C	C
Cylinder Ordering Code	TCGM- VI-0300NFC	TCGM- VI-0400LFC	TCGM- VI-0500LFC	TCGM- VI-0800LFC	TCGM- VI-1000LFC	TCGM- VI-1250LFC	TCGM- VI-1500LFC
Unvented Kit Ordering Code	Inc.	Inc.	Inc.	Inc.	Inc.	Inc.	Inc.

Commercial Multi Energy - 3bar

Product	300	400	500	800	1000	1250	1500
Cylinder Height (A, mm)	1670	1670	2030	2050	2090	2200	2400
Cylinder Diameter (B, mm)	620	710	710	920	1100	1150	1150
Weight Empty (kg)	71.5	72	89	186	188	191	207
Weight Full (kg)	361	463	586	952	1285	1422	1617
ErP Rating	C	C	C	C	C	C	C
Cylinder Ordering Code	TCFM- VD-0300LFD	TCFM- VD-0400LFD	TCFM- VD-0500LFD	TCFM- VD-0800LFD	TCFM- VD-1000LFD	TCFM- VD-1250LFD	TCFM- VD-1500LFD
Unvented Kit Ordering Code	Inc.	Inc.	Inc.	TYD-32-03- 080L	TYD-32-03- 100L	Inc.	Inc.

Commercial Multi Energy - 6bar

Product	300	400	500	800	1000	1250	1500
Cylinder Height (A, mm)	1670	1670	2030	2050	2090	2200	2400
Cylinder Diameter (B, mm)	620	710	710	920	1100	1150	1150
Weight Empty (kg)	71.5	72	89	186	188	191	207
Weight Full (kg)	361	463	586	952	1285	1422	1617
ErP Rating	C	C	C	C	C	C	C
Cylinder Ordering Code	TCGM- VD-0300NFD	TCGM- VD-0400LFD	TCGM- VD-0500LFD	TCGM- VD-0800LFD	TCGM- VD-1000LFD	TCGM- VD-1250LFD	TCGM- VD-1500LFD
Unvented Kit Ordering Code	Inc.	Inc.	Inc.	Inc.	Inc.	Inc.	Inc.

Commercial Solar - 3bar

Product	300	400	500	800	1000	1250	1500
Cylinder Height (A, mm)	1670	1670	2030	2050	2090	-	-
Cylinder Diameter (B, mm)	620	710	710	920	1020	-	-
Weight Empty (kg)	88	89	105.5	240	250	-	-
Weight Full (kg)	366.5	466	588	972	1313	-	-
ErP Rating	C	C	C	C	C	-	-
Cylinder Ordering Code	TCFM- VS-0300NFC	TCFM- VS-0400LFC	TCFM- VS-0500LFC	TCFM- VS-0800LFC	TCFM- VS-1000LFC	-	-
Unvented Kit Ordering Code	Inc.	Inc.	Inc.	Inc.	Inc.	-	-

Commercial Solar - 6bar

Product	300	400	500	800	1000	1250	1500
Cylinder Height (A, mm)	1670	1670	2030	2050	2090	-	-
Cylinder Diameter (B, mm)	620	710	710	920	1020	-	-
Weight Empty (kg)	88	89	105.5	240	250	-	-
Weight Full (kg)	366.5	466	588	972	1313	-	-
ErP Rating	C	C	C	C	C	-	-
Cylinder Ordering Code	TCGM- VS-0300NFC	TCGM- VS-0400LFC	TCGM- VS-0500LFC	TCGM- VS-0800LFC	TCGM- VS-1000LFC	-	-
Unvented Kit Ordering Code	Inc.	Inc.	Inc.	Inc.	Inc.	-	-

Option Of Inspection Flange Available on Request - Not Included As Standard
Custom Specification Models Available

Immersion Heaters

Description	Ordering Code
3KW 1PH Incloy Imm. Screw Dom	TH-L-14-03-1
3KW 1PH Smart Incloy Imm. Screw	TH-S-14-03-1
6KW 1PH Incloy Imm. Screw	TH-L-14-06-1
6KW 3PH Incloy Imm. Screw	TH-L-14-06-3
9KW 1PH Incloy Imm. Screw	TH-L-14-09-1
9KW 3PH Incloy Imm. Screw	TH-L-16-09-3
12KW 3PH Incloy Imm. Screw	TH-L-16-12-3
18KW 3PH Incloy Imm. Flange	TH-M-36-18-3
24KW 3PH Incloy Imm. Flange	TH-M-36-24-3
30KW 3PH Incloy Imm. Flange	TH-M-36-30-3
36KW 3PH Incloy Imm. Flange	TH-M-36-36-3
40KW 3PH Incloy Imm. Flange	TH-M-36-40-3
45KW 3PH Incloy Imm. Flange	TH-M-36-45-3
54KW 3PH Incloy Imm. Flange	TH-M-36-54-3
3Kw 1PH Titanium Imm. Screw	TI-T-L-14-03-1
6Kw 1PH Titanium Imm. Screw	TI-T-L-16-06-1
6Kw 3PH Titanium Imm. Screw	TI-T-L-16-06-3
9Kw 3PH Titanium Imm. Screw	TI-T-L-16-09-3
12Kw 3PH Titanium Imm. Screw	TI-T-L-18-12-3

Introducing the Joule air source Heat pump powered by Samsung

The ultimate in home climate convenience is here, thanks to ClimateHub - Samsung's new integrated solution for heating and domestic hot water supply.

With straightforward installation, smooth commissioning, quiet operation and smart connectivity, maintaining home comfort has finally been made easy.



Air Source Heat Pumps

A heat pump is an energy-efficient system that uses the heat from the ambient air for heating and hot water. By using the ambient air and transferring this heat into the house through a hydronic system, such as underfloor heating, a heat pump requires less power input and offers greater power output than conventional boilers.



SAMSUNG IN QUIET MODE IS QUIETER THAN MITSUBISHI ULTRA QUIET

Today's climate systems need to meet increasingly strict sound level requirements and limit aural disturbance around the home. The Samsung ClimateHub system's 4-Step Quiet Mode allows users to reduce noise levels of the heat pump outdoor unit to as low as 35dB(A).



CONNECTS INTO SMART THINGS CONTROL ENVIRONMENT

The ClimateHub system can be managed remotely. Using the optional Wi-Fi kit, users can control different aspects of the system through the Samsung SmartThings app turn it on and off, control the functions and schedule its operation, from anywhere

How it works?

A heat pump is an electrical device that extracts heat from one place and transfers it to another. The heat pump is not a new technology; it has been used around the world for decades. Refrigerators and air conditioners are both common examples of this technology.

Heat pumps transfer heat by circulating refrigerant through a cycle of evaporation and condensation. A compressor pumps the refrigerant between two heat exchanger coils. In one coil, the refrigerant is evaporated at low pressure and absorbs heat from its surroundings.

The refrigerant is then compressed en route to the other coil, where it condenses at high pressure. At this point, it releases the heat it absorbed earlier in the cycle.

Refrigerators and air conditioners are both examples of heat pumps operating only in the cooling mode. A refrigerator is essentially an insulated box with a heat pump system connected to it.

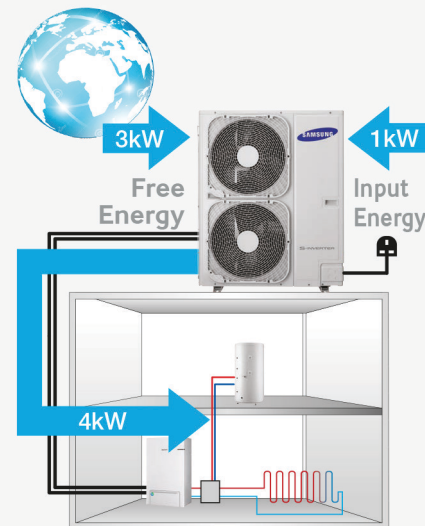

For every 1 kWh of energy input

=

An air source heat pump can deliver up to more than 4 kWh in energy output.

This is an energy efficiency ratio of more than 400%, which is far superior to high energy efficiency boiler systems.

Our heatpump packages have class leading SCOP.

Air Source Heat Pump Benefits

- Compatible with all low temp. systems
- High seasonal energy efficiency
- Up to 60°C water supply
- Easy to install - Easy to control
- Operation Range down to -20°C
- Higher capacity at low ambient temperature

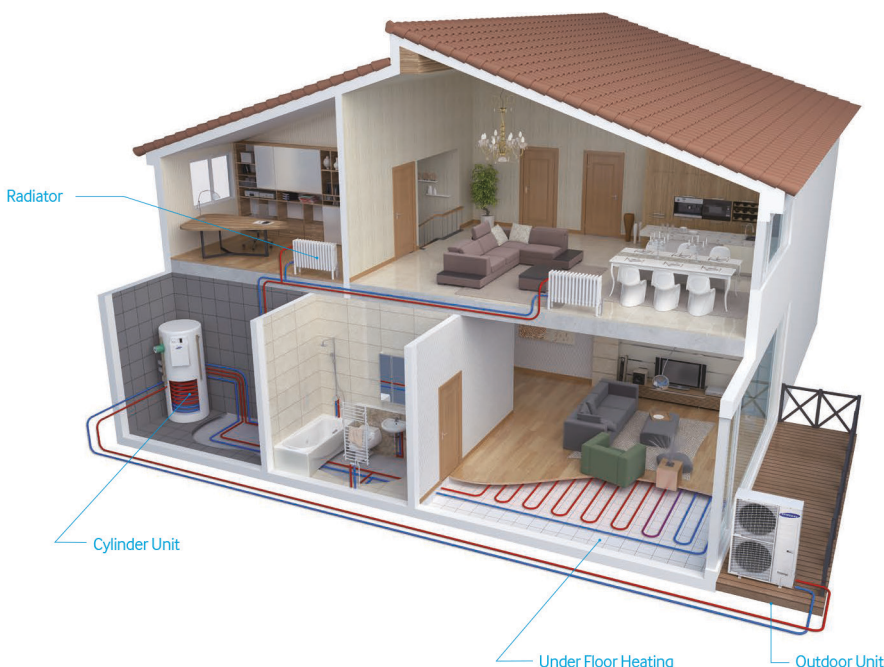



in conjunction with

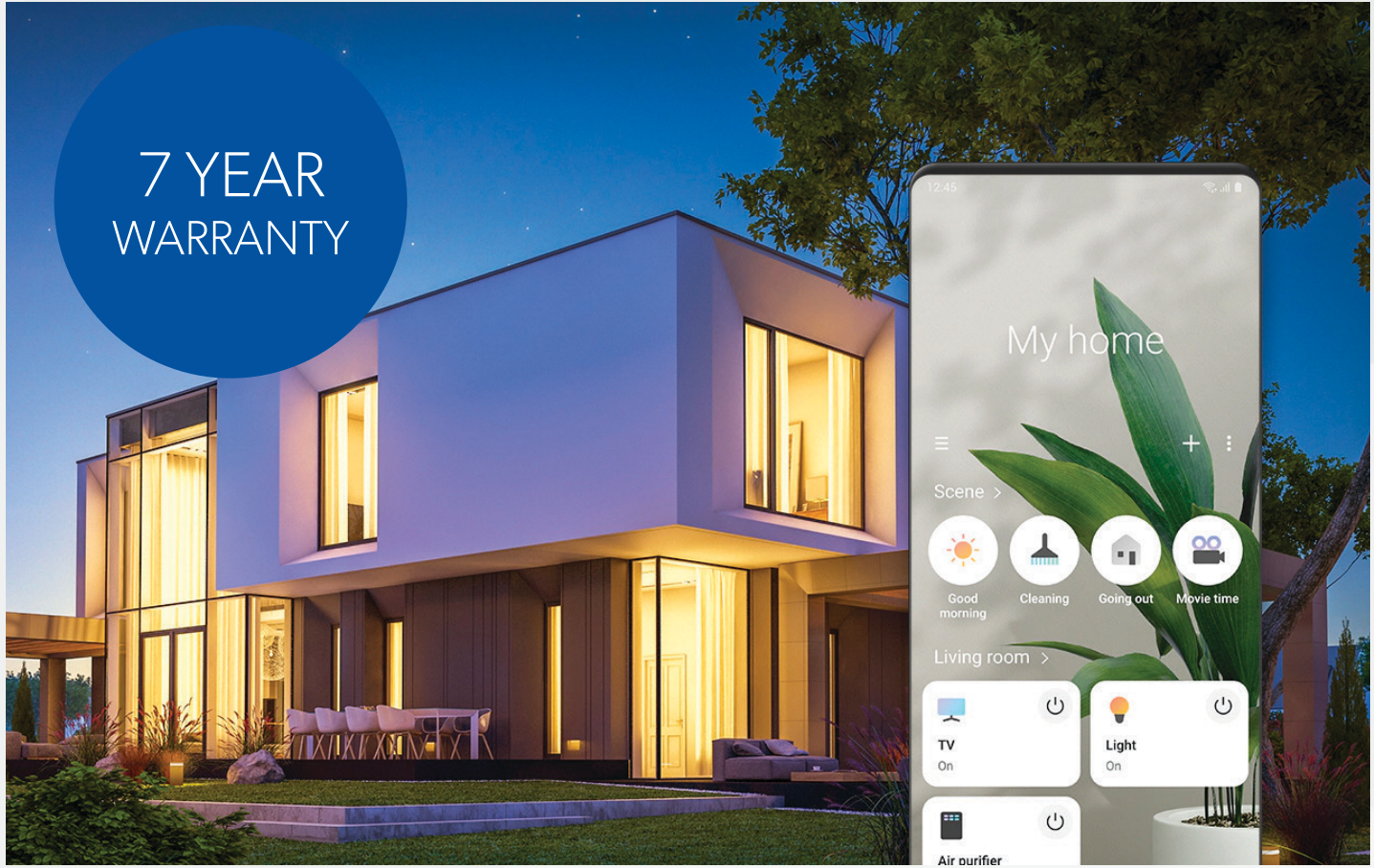

Hands-free control.

Use Bixby on your Galaxy phone to control your smart devices with your voice.

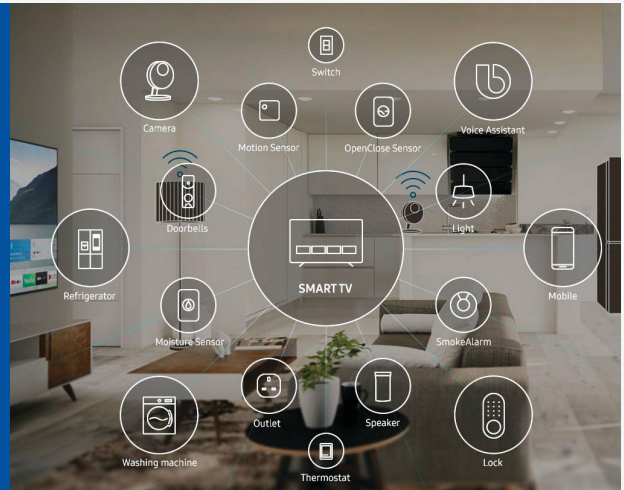

Smart Applications:



More available at: <https://www.samsung.com/uk/apps/smartthings/>

More smart devices, one smart app.

Connect, automate, and manage all your Samsung and SmartThings-compatible appliances and electronics with a single, easy-to-use app.

Because smart should be simple, however many devices you bring home.

Connects Into Smart Things Control Environment

Connect to your heatpump and smart cylinder from the comfort of your living room.

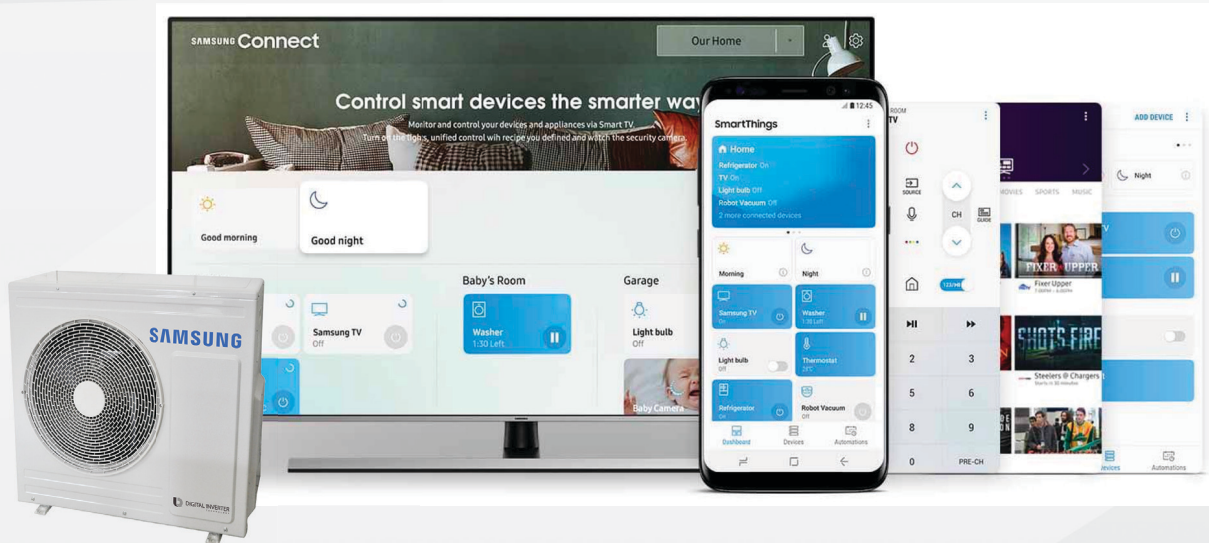

One App, Multiple Screens.

Access SmartThings features across a family of Samsung products, including smart phones, TVs, and fridges.

Your Home, Your Way.

Make your home smarter with custom automation. Create schedules and scenarios, and let SmartThings do the rest.

It can even suggest new smart ways to automate your day.

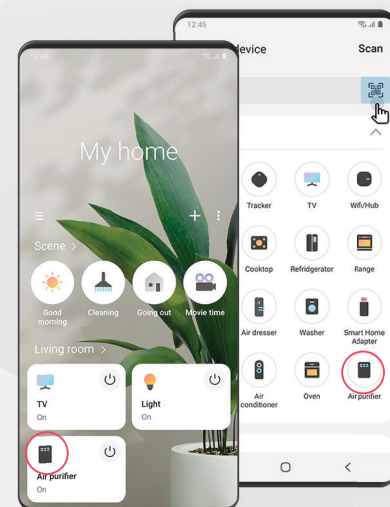

Joule-Samsung Air Source Heat Pump Product Range

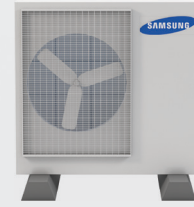

R32 Outdoor Unit

HHSM-G600005-1	HHSM-G600008-1	HHSM-G600012-1	HHSM-G600016-1	HHSM-G600016-3
----------------	----------------	----------------	----------------	----------------

		5kW	8kW	12kW	16kW	16kW
Capacity						
Power		1				3
Packaged						
HUGH-180COM-3C	180L COMPACT	●	●	●	●	
HUGH-230COM-3C	230L COMPACT	●	●	●	●	
Pre-Plumbed						
HUGH-G6150-L3C	150L STANDARD	●	●			
HUGH-G6170-L3C	170L STANDARD	●	●	●		
HUGH-G6200-L3C	200L STANDARD	●	●			
HUGH-G6250-N3C	250L STANDARD		●	●	●	●
HUGH-G6300-N3C	300L STANDARD			●	●	●
HUGH-G6150-S3C	150L SLIMLINE	●	●			
HUGH-G6170-S3C	170L SLIMLINE	●	●	●		
HUGS-G6200-L3C	200L SOLAR	●				
HUGS-G6250-N3C	250L SOLAR			●	●	●
HUGS-G6300-N3C	300L SOLAR		●		●	●
Standalone						
	1PH SO SYS	●	●	●	●	
	3PH SO SYS				●	●
Buffer						
HUGH-G61860-3C	MONO 180/60L	●	●	●		
HUGH-G62060-3C	MONO 200/60L	●	●	●	●	●
HUGH-G62590-3C	MONO 250/90L		●	●	●	●
HUGH-G63090-3C	MONO 300/90L		●	●	●	●
HUGH-G63013-3C	MONO 300/130L		●	●	●	●
HUGH-G64013-3C	MONO 400/130L			●	●	●



Tank Integrated Hydro Unit & Smart Plumb Cylinder

Joule-Samsung MonoSpecification



AIR SOURCE HEAT PUMP

				Outdoor Unit	HHSM-G600005-1	HHSM-G600008-1	HHSM-G600012-1	HHSM-G600016-1	
				Controller	HZSMC-G6000000	HZSMC-G6000000	HZSMC-G6000000	HZSMC-G6000000	
System	Operation	Nominal Capacity	Heating A7/W35 ¹ /A7/W55 ²	W	5.000/4.300	8.000/7.100	12.000/11.300	16.000/15.000	
			Cooling A35/W18 ¹	W	5.000	7.500	12.000	14.000	
		Power Input (Nominal)	Heating A7/W35 ¹ /A7/W55 ²	W	1.030/1.520	1.770/2.530	2.650/3.730	3.620/5.180	
			Cooling A35/W18 ¹	W	1.140	1.900	2.770	3.280	
		COP (Nominal Heating) A7/W35 ¹ /A7/W55 ²		W/W	4,85/2,83	4,52/2,81	4,53/3,03	4,42/2,90	
		EER (Nominal Cooling) A35/W18 ¹		W/W	4,39	3,95	4,33	4,27	
		SCOP LWT 350°/550°		W/W	4,46/3,2	4,44/3,23	4,69/3,51	4,48/3,53	
		Average Seasonal Space Heating Eff.Class*		-	A+++/A++	A+++/A++	A+++/A++	A+++/A++	
		Current	MCA	A	16,00	22,00	28,00	32,00	
			MFA	A	20,00	27,50	35,00	40,00	
		Water Flow Rate	Min	l/min	7,00	7,00	12,00	12,00	
			Max	l/min	48,00	48,00	58,00	58,00	
		Leaving Water Temp	Heating	OC	15-65	15-65	15-65	15-65	
			Cooling	OC	5-25	5-25	5-25	5-25	
		Function	Smart Grid Ready	-	●	●	●	●	
		PV Enabled	-	●	●	●	●		
		2-Zone Control	-	●	●	●	●		
Indoor Compact Unit	Power Supply			0,#,V,Hz	220-240V, 50Hz, 1	220-240V, 50Hz, 1	220-240V, 50Hz, 1	220-240V, 50Hz, 1	
	Water Tank Volume			Litres	180/230	180/230	180/230	180/230	
	Declared Load Profile			L/XL					
	Energy Efficiency Class			-	A	A	A	A	
	Sound	Sound Pressure	Heating/ Cooling Std		dB(A)				
		Sound Power	Heating Std		dB(A)				
	Dimensions	Net Weight			kg	58.5	76.0	110.0	110.0
Net Dimensions (WxHxD)				mm	798x 880 x 310	998 x 940 x 330	1420 x 940 x 330	1420 x 940 x 330	
Outdoor Unit	Power Supply			0,#,V,Hz	10,220-240V,50Hz	10,220-240V,50Hz	10,220-240V,50Hz	10,220-240V,50Hz	
	Compressor	Type		-	BLDC Twin Rotary	BLDC Twin Rotary	BLDC Twin Rotary	BLDC Twin Rotary	
	Base Heater			-	-	●	●	●	
	Sound	Sound	Heating Std		dB(A)	45	48	50	52
		Pressure	Cooling Std		dB(A)	45	48	50	54
		Sound	Heating Std		dB(A)	61	63	64	66
		Power	Cooling Std		dB(A)	62	64	65	68
	Dimensions	Net Weight			Kg	58.5	76	110	110
		Net Dimensions (WxHxD)			mm	880 x 798 x 310	940 x 998 x 330	940 x 1420 x 330	940 x 1420 x 330
	Refrigerant	Type			-	R32	R32	R32	R32
		Factory Charging			tCO2e	0,68	0,78	1,49	1,49
					kg	1,00	1,15	2,20	2,20
	Piping	Water Pipe	Inlet/Outlet		0,mm	28/28	28/28	28/28	28/28
Water Pipe (DHW)		Inlet/Outlet		0,mm	22/22	22/22	22/22	22/22	
Operation	Ambient Temperature	Heating		OC	-25-35	-25-35	-25-35	-25-35	
		Cooling		OC	10-46	10-46	10-46	10-46	

Standard Pre-Plumbed Cylinder For Joule Samsung Monobloc Units

Joule hot water cylinders are next generation in pre-plumbed hot water solutions. With its sleek design and pre-plumbed architecture the space requirements for the pre-plumbed hot water cylinder have been reduced dramatically.

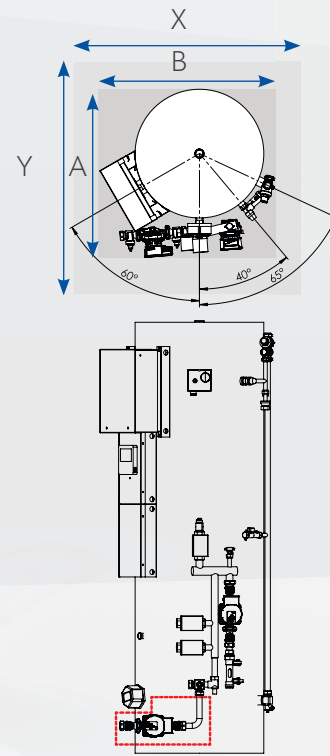

CYLINDER		HUGH-G6150-L3C	HUGH-G6170-L3C	HUGH-G6200-L3C	HUGH-G6250-N3C	HUGH-G6300-N3C	
NOMINAL HOT WATER VOLUME (LITRES)		150	170	200	250	300	
ErP RATING		C	C	C	C	C	
STANDING LOSS (W)		55	66	81	89	92	
HEAT UP TIME (MINS)		10	10	11	14	17	
WATER		Primary Circuit Pump	Wilco- Yonos PARA RS 15/7.0 iPWM1 130 12				
		Heating Circuit Pump					
		Connection Size (mm) Heating / DHW					22 / 22
WATER SAFETY	Water Circuit	Control Thermistor (°C)	80				
	DHW Cylinder	DHW Expansion Vessel (Litres)	18	18	18	18	24
		Control Thermistor (°C)	75	75	75	75	75
		Over Temperature Cut-Out (°C)	80 ± 5				
		Temp and Pressure Relief Valve (°C) / (MPa (Bar))	90 / 1.0 (10)				
		Expansion Relief Valve (Cold) (MPa (Bar))	0.6 (6)				
DIMENSIONS (mm)		Height	1190	1310	1490	1815	1600
		Width	540	540	540	540	600
FOOTPRINT (mm)		Length (A)	740			800	
		Width (B)	740			800	
FREE FLOOR SPACE (mm)		Length (X)	1290			1350	
		Width (Y)	840			900	
WEIGHT EMPTY / FULL (kg)		46/196	54/223	58/256	67/316	74/372	
CYLINDER MATERIAL		Cylinder	Stainless Steel Duplex LDX 2101				
		Insulation	Insulation Type	Polyurethane foam CFC-Free and HCFC Free			
			Insulation Thickness (mm)	50			
			GWP of Insulation	3.1			
			ODP of Insulation	0			
ELECTRICAL DATA		Electrical Supply MIM	220-240v, 50Hz				
		Phase	Single				
		Fuse Rating - MCB Sizes (A)*1	16				
		Imersion Capacity (kW)	3				
		Max Running Current (A)	13				
		Fuse Rating - MCB Sizes (A)*1	16				

Slimline Pre-Plumbed Cylinder For Joule Samsung Monobloc Units

Joule Cyclone Slimline cylinders have been designed for the use in tight areas where there is more height than width available.

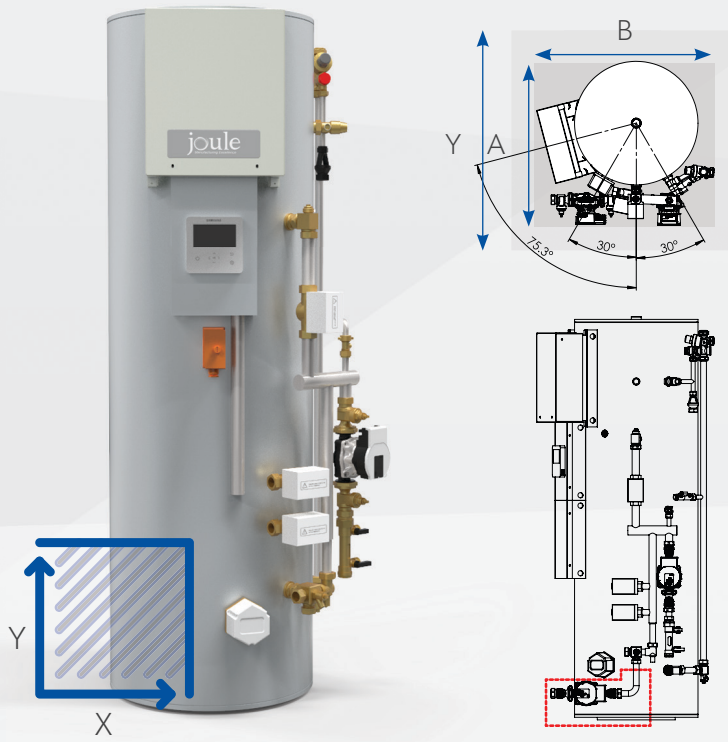

CYLINDER		HUGH-G6150-S3C	HUGH-G6170-S3C	HUGH-G6205-S3C	
NOMINAL HOT WATER VOLUME (LITRES)		150	170	205	
ErP RATING		C	C	C	
Standing Loss (W)		70	79	84	
Heat Up Time (mins)		26	27	31	
WATER		Primary Circuit Pump Heating Circuit Pump Connection Size (mm) Heating / DHW			
		Wilco- Yonos PARA RS 15/7.0 iPWM1 130 12			
		22 / 22			
WATER SAFETY	DHW Cylinder	Control Thermistor (°C)			
		80			
		DHW Expansion Vessel (Litres)			
		18			
		Control Thermistor (°C)			
75					
Over Temperature Cut-Out (°C)					
80 ± 5					
Temp and Pressure Relief Valve (°C) / (MPa (Bar))					
90 / 1.0 (10)					
Expansion Relief Valve (Cold) (MPa (Bar))					
0.6 (6)					
DIMENSIONS (mm)		Height	1335	1535	1880
		Width	475		
FOOTPRINT (mm)		Length (A)	675		
		Width (B)	675		
FREE FLOOR SPACE (mm)		Length (X)	1225		
		Width (Y)	775		
WEIGHT EMPTY / FULL (kg)		35 / 175	39 / 199	43 / 230	
CYLINDER MATERIAL	Cylinder	Cylinder Material			
	Insulation	Stainless Steel Duplex LDX 2101			
		Insulation Type			
		Polyurethane foam CFC-Free and HCFC Free			
		Insulation Thickness (mm)			
50					
GWP of Insulation					
3.1					
ODP of Insulation					
0					
ELECTRICAL DATA		Electrical Supply			
		220-240v, 50Hz			
		Phase			
		Single			
		Fuse Rating - MCB Sizes (A)*1			
		16			
		Capacity (kW)			
		3			
		Max Running Current (A)			
		13			
		Fuse Rating - MCB Sizes (A)*1			
		16			

Compact Pre-Plumbed Cylinder For Joule Samsung Monobloc Units

The new and innovative Smart Plumb Compact has been designed to not only look modern and minimise footprint for homeowners, but it also has been designed to benefit installers.

Having all main components easily accessible proves maintenance simple, as well as strategically assigning all valves to be part of one unit concludes everything being in a single place logically makes the job at hand simple, less time consuming and cost effective.



CYLINDER			HUGH-180COM-3C	HUGH-230COM-3C
NOMINAL HOT WATER VOLUME (LITRES)			180L	230L
HEAT PUMP COMBINATION HEATER - Large Profile (Average Climate) ErP Rating			C	
OPERATING AMBIENT TEMPERATURE (°C DB)			0 ~ +35°C (RH<80%)	0 ~ +35°C (RH<80%)
SOUND PRESSURE LEVEL AT 1M (dBA)			28	28
WATER		Primary Circuit Pump	willo- Yonos PARA RS 15	
		Sanitary Hot Water Pump		
		Connection Size (mm) Heating / DHW	28 / 22	28 / 22
WATER SAFETY DEVICES	Water Circuit	Control Thermistor (°C)	1 - 80	1 - 80
		Flow Sensor (minimum flow 7L/min)	Supplied	Supplied
	DHW Cylinder	Control Thermistor (°C)	75	75
		Temp and Pressure Relief Valve (°C)/ (MPa (Bar))	90 / 0.7 (7)	
DIMENSIONS (mm)		Width	595	
		Height	1900	
FOOTPRINT (mm)		Length (A)	620	
		Width (B)	595	
FREE FLOOR SPACE (mm)		Length (X)	595	
		Width (Y)	1020	
WEIGHT EMPTY / FULL (kg)			85 / 265	90 / 320
ELECTRICAL DATA		Electrical Supply	220-240v, 50Hz	
		Phase	Single	
		Fuse Rating - MCB Sizes (A)*1	20	
		Immersion Capacity (kW)	3	
		Max Running Current (A)	16	
		Fuse Rating - MCB Sizes (A)*1	20	

Smart Plumb Pre-Plumbed Cylinder For Joule Samsung Monobloc Units

The Smart Plumb by Joule is the most innovative pre-plumbed solution for heat pump systems. The cylinder / buffer combo is pre-plumbed, wired and commissioned before it leaves the factory.

The buffer acts as an intermediary vessel for the heating system which helps system flow rate and defrost cycling. With the cylinder sitting over the buffer tank the foot print has been greatly reduced. The control wires are all hidden behind the cable cover.

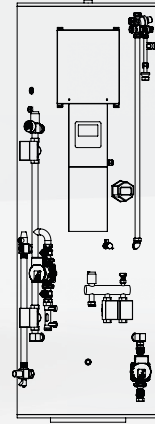
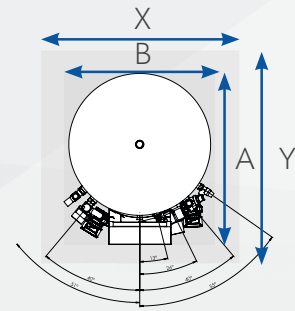

CYLINDER		HUGH-G61860-3C	HUGH-G62060-3C	HUGH-G62590-3C	HUGH-G63090-3C	HUGH-G63013-3C	HUGH-G64013-3C								
NOMINAL HOT WATER VOLUME (LITRES)		180L/60L	200L/60L	250L/90L	300L/90L	300L/130L	400L/130L								
ErP RATING		B/B	C/B	C/B	C/B	C/B	C/B								
STANDING LOSS (W)		68	83	90	94	94	102								
WATER		Primary Circuit Pump		Wilo - Yonos PARA RS 15											
		Heating Circuit Pump													
		Connection Size (mm) Heating / DHW						22mm		28mm					
WATER SAFETY		Water Circuit		Control Thermistor (°C)				80							
		DHW Cylinder		DHW Expansion Vessel (Litres)				18							
				Control Thermistor (°C)				75							
				Over Temperature Cut-Out (°C)				80 ± 5							
				Temp and Pressure Relief Valve (°C) / (MPa (Bar))				90/0,7(7)							
Expansion Relief Valve (Cold) (MPa (Bar))				0,6 (6)											
DIMENSIONS (mm)		Width		560		660		710							
		Height		1870		1980		1950		1850		2160			
FOOTPRINT (mm)		Length (A)		740		800		910							
		Width (B)		740		800		910							
FREE FLOOR SPACE (mm)		Length (X)		1290		1350		1460							
		Width (Y)		840		900		1010							
WEIGHT EMPTY / FULL (kg)		78/ 318		83/ 343		92/ 432		96/ 451		101/ 491		113/ 643			
CYLINDER MATERIAL		Cylinder		Cylinder Material								Stainless Steel Duplex LDX 2101			
		Insulation		Insulation Type								Polyurethane foam CFC-Free and HCFC Free			
				Insulation Thickness (mm)								50			
				GWP of Insulation								3,1			
				ODP of Insulation								0			
ELECTRICAL DATA		Electrical Supply		220-240v, 50Hz											
		Phase		Single											
		Fuse Rating - MCB Sizes (A)*1		20											
		Immersion Capacity (kW)		3											
		Max Running Current (A)		16											

Joule-Samsung 5kW Monobloc Air Source Heat Pump

HHSM-G600005-1

Solution Key Features

- 7 year Warranty
- SCOP: Best on MCS Database – 4.85
- 65°C Hot Water
- <45dB(A) - Quietest System on the Market
- 5Kw Outputs
- Low GWP Refrigerant – R32



SYSTEM PRICE			INDOOR UNIT		
Ref Code	Ref Code Description		Dimensions (H x W x D)	Breaker (A) ²	Pipe Size (mm) ³
Packaged					
HXSM-G6-011*	(HXSM-G6-016)*	SAMSUNG MONO 5 - 4.35KW 1PH 180L COMPACT	1900 x 595 x 620	20 & 20	28 / 22
HXSM-G6-131*	(HXSM-G6-136)*	SAMSUNG MONO 5 - 4.35KW 1PH 230L COMPACT	1900 x 595 x 620	20 & 20	28 / 22
Pre-Plumbed					
HXSM-G6-031*	(HXSM-G6-048)*	SAMSUNG MONO 5 - 4.35KW 1PH 150L STANDARD	1190 x 740 x 740	20 & 20	28 / 22
HXSM-G6-032*	(HXSM-G6-049)*	SAMSUNG MONO 5 - 4.35KW 1PH 170L STANDARD	1310 x 740 x 740	20 & 20	28 / 22
HXSM-G6-033*	(HXSM-G6-050)*	SAMSUNG MONO 5 - 4.35KW 1PH 200L STANDARD	1490 x 740 x 740	20 & 20	28 / 22
HXSM-G6-021*	(HXSM-G6-026)*	SAMSUNG MONO 5 - 4.35KW 1PH 150L SLIMLINE	1335 x 675 x 675	20 & 20	28 / 22
HXSM-G6-022*	(HXSM-G6-027)*	SAMSUNG MONO 5 - 4.35KW 1PH 170L SLIMLINE	1535 x 675 x 675	20 & 20	28 / 22
HXSM-G6-065*	(HXSM-G6-079)*	SAMSUNG MONO 5 - 4.35KW 1PH 200L SOLAR	1513 x 683 x 730	20 & 20	28 / 22
HXSM-G6-066*	(HXSM-G6-080)*	SAMSUNG MONO 5 - 4.35KW 1PH 250L SOLAR	1760 x 545	20 & 20	28 / 22
Standalone					
HXSM-G6-001**	(HXSM-G6-006)**	SAMSUNG MONO 5 - 4.35KW 1PH SO SYS	422 x 393 x 87	Via ODU or 20	28 / 22-
Buffer					
HXSM-G6-093*	(HXSM-G6-108)*	SAMSUNG MONO 5 - 4.35KW 1PH HP MONO 180/60	1600 x 650 x 730	20 & 20	28 / 22
HXSM-G6-094*	(HXSM-G6-109)*	SAMSUNG MONO 5 - 4.35KW 1PH HP MONO 200/60	1800 x 650 x 730	20 & 20	28 / 22

Included Components *: Outdoor Unit, Insulated Flexible Connection Pipes, 1" Y Pattern Strainer With Isolation and Pre Plumbed Cylinder
 Included Components **: Outdoor Unit, Insulated Flexible Connection Pipes, 1" Y Pattern Strainer With Isolation and Mono Control Center

Joule-Samsung 8kW Monobloc Air Source Heat Pump

HHSM-G600008-1

Solution Key Features

- 7 year Warranty
- SCOP: Best on MCS Database – 4.52
- 65°C Hot Water
- <48DbdB - Quietest System on the Market
- 8Kw Outputs
- Low GWP Refrigerant – R32

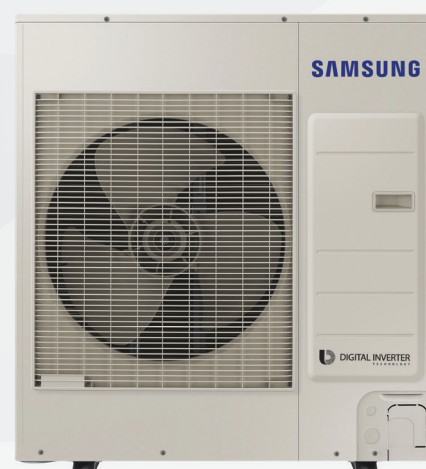

AIR SOURCE HEAT PUMP

SYSTEM PRICE			INDOOR UNIT		
Ref Code	Ref Code Description	Dimensions (H x W x D)	Breaker (A) ^{1,2}	Pipe Size (mm) ^{1,3}	
Packaged					
HXSM-G6-012*	(HXSM-G6-017)*	SAMSUNG MONO 8 - 6.37KW 1PH 180L COMPACT	1900 x 595 x 620	20 & 20	28 / 22
HXSM-G6-132*	(HXSM-G6-137)*	SAMSUNG MONO 8 - 6.37KW 1PH 230L COMPACT	1900 x 595 x 620	20 & 20	28 / 22
Pre-Plumbed					
HXSM-G6-034*	(HXSM-G6-051)*	SAMSUNG MONO 8 - 6.37KW 1PH 150L STANDARD	1190 x 740 x 740	20 & 20	28 / 22
HXSM-G6-035*	(HXSM-G6-052)*	SAMSUNG MONO 8 - 6.37KW 1PH 170L STANDARD	1310 x 740 x 740	20 & 20	28 / 22
HXSM-G6-036*	(HXSM-G6-053)*	SAMSUNG MONO 8 - 6.37KW 1PH 200L STANDARD	1490 x 740 x 740	20 & 20	28 / 22
HXSM-G6-037*	(HXSM-G6-054)*	SAMSUNG MONO 8 - 6.37KW 1PH 250L STANDARD	1815 x 740 x 740	20 & 20	28 / 22
HXSM-G6-023*	(HXSM-G6-028)*	SAMSUNG MONO 8 - 6.37KW 1PH 150L SLIMLINE	1335 x 675 x 675	20 & 20	28 / 22
HXSM-G6-024*	(HXSM-G6-029)*	SAMSUNG MONO 8 - 6.37KW 1PH 170L SLIMLINE	1535 x 675 x 675	20 & 20	28 / 22
HXSM-G6-067*	(HXSM-G6-081)*	SAMSUNG MONO 8 - 6.37KW 1PH 210L SOLAR	1510 x 545	20 & 20	28 / 22
HXSM-G6-068*	(HXSM-G6-082)*	SAMSUNG MONO 8 - 6.37KW 1PH 250L SOLAR	1760 x 545	20 & 20	28 / 22
HXSM-G6-069*	(HXSM-G6-083)*	SAMSUNG MONO 8 - 6.37KW 1PH 300L SOLAR	1980 x 545	20 & 20	28 / 22
Standalone					
HXSM-G6-002**	(HXSM-G6-007)**	SAMSUNG MONO 8 - 6.37KW 1PH SO SYS	422 x 393 x 87	Via ODU or 16	28 / 22
Buffer					
HXSM-G6-095*	(HXSM-G6-110)*	SAMSUNG MONO 8 - 6.37KW 1PH JOULE HP MONO 180/60L	1870 x 540	20 & 20	28 / 22
HXSM-G6-096*	(HXSM-G6-111)*	SAMSUNG MONO 8 - 6.37KW 1PH JOULE HP MONO 200/60L	1980 x 540	20 & 20	28 / 22
HXSM-G6-097*	(HXSM-G6-112)*	SAMSUNG MONO 8 - 6.37KW 1PH JOULE HP MONO 250/90L	1670 x 600	20 & 20	28 / 22
HXSM-G6-123*	(HXSM-G6-127)*	SAMSUNG MONO 8 - 6.37KW 1PH JOULE HP MONO 300/130L	1850 x 710	20 & 20	28 / 22

Included Components *: Outdoor Unit, Insulated Flexible Connection Pipes, 1" Y Pattern Strainer With Isolation and Pre Plumbed Cylinder

Included Components **: Outdoor Unit, Insulated Flexible Connection Pipes, 1" Y Pattern Strainer With Isolation and Mono Control Center

Recommended Components: 20l Concentrate Hp Fluid and Anti-Vibration Fix-It Foot 600mm Kit

Joule-Samsung 12kW Monobloc Air Source Heat Pump

HHSM-G600012-1

Solution Key Features

- 7 year Warranty
- SCOP: Best on MCS Database – 4.53
- 65°C Hot Water
- <50DbdB - Quietest System on the Market
- 12Kw Outputs
- Low GWP Refrigerant – R32

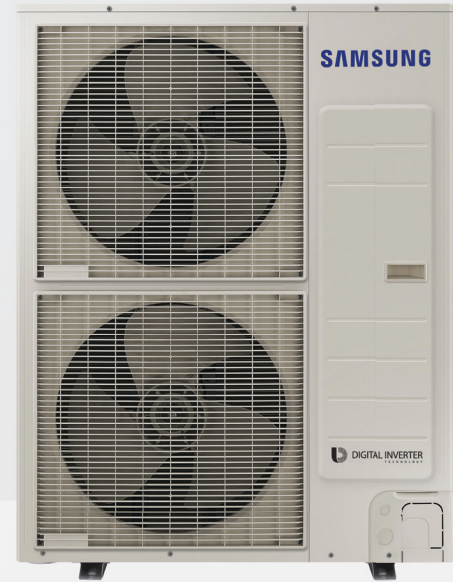

SYSTEM PRICE			INDOOR UNIT		
Ref Code	Ref Code Description	Dimensions (H x W x D)	Breaker (A) ²	Pipe Size (mm) ³	
Packaged					
HXSM-G6-013*	(HXSM-G6-018)*	SAMSUNG MONO 12 - 10.43KW 1PH 180L COMPACT	1900 x 595 x 620	32 & 32	28 / 22
HXSM-G6-133*	(HXSM-G6-138)*	SAMSUNG MONO 12 - 10.43KW 1PH 230L COMPACT	1900 x 595 x 620	32 & 32	28 / 22
Pre-Plumbed					
HXSM-G6-038*	(HXSM-G6-055)*	SAMSUNG MONO 12 - 10.43KW 1PH 170L STANDARD	1310 x 740 x 740	32 & 32	22 / 22
HXSM-G6-039*	(HXSM-G6-056)*	SAMSUNG MONO 12 - 10.43KW 1PH 200L STANDARD	1490 x 740 x 740	32 & 32	22 / 22
HXSM-G6-040*	(HXSM-G6-057)*	SAMSUNG MONO 12 - 10.43KW 1PH 250L STANDARD	1815 x 740 x 740	32 & 32	22 / 22
HXSM-G6-041*	(HXSM-G6-058)*	SAMSUNG MONO 12 - 10.43KW 1PH 300L STANDARD	1600 x 800 x 800	32 & 32	22 / 22
HXSM-G6-025*	(HXSM-G6-030)*	SAMSUNG MONO 12 - 10.43KW 1PH 170L SLIMLINE	1535 x 675 x 675	32 & 32	22 / 22
HXSM-G6-070*	(HXSM-G6-084)*	SAMSUNG MONO 12 - 10.43KW 1PH 200L SOLAR	1510 x 545	32 & 32	22 / 22
HXSM-G6-071**	(HXSM-G6-085)*	SAMSUNG MONO 12 - 10.43KW 1PH 250L SOLAR	1760 x 545	32 & 32	22 / 22
HXSM-G6-072*	(HXSM-G6-086)*	SAMSUNG MONO 12 - 10.43KW 1PH 300L SOLAR	1980 x 545	32 & 32	22 / 22
Standalone					
HXSM-G6-003**	(HXSM-G6-008)**	SAMSUNG MONO 12 - 10.43KW 1PH SO SYS	422 x 393 x 87	Via ODU or 32	22 / 22
Buffer					
HXSM-G6-098*	(HXSM-G6-113)*	SAMSUNG MONO 12 - 10.43KW 1PH JOULE HP MONO 180/60	1870 x 540	32 & 32	22 / 22
HXSM-G6-099*	(HXSM-G6-114)*	SAMSUNG MONO 12 - 10.43KW 1PH JOULE HP MONO 200/60	1980 x 540	32 & 32	22 / 22
HXSM-G6-100*	(HXSM-G6-115)*	SAMSUNG MONO 12 - 10.43KW 1PH JOULE HP MONO 250/90	1670 x 600	32 & 32	22 / 22
HXSM-G6-101*	(HXSM-G6-116)*	SAMSUNG MONO 12 - 10.43KW 1PH JOULE HP MONO 300/13	1850 x 710	32 & 32	22 / 22
HXSM-G6-124*		SAMSUNG MONO 12 - 10.43KW 1PH JOULE HP MONO 400/13	2160 x 710	32 & 32	22 / 22

Included Components *: Outdoor Unit, Insulated Flexible Connection Pipes, 1" Y Pattern Strainer With Isolation and Pre Plumbed Cylinder

Included Components **: Outdoor Unit, Insulated Flexible Connection Pipes, 1" Y Pattern Strainer With Isolation and Mono Control Center

Recommended Components: 20l Concentrate Hp Fluid and Anti-Vibration Fix-It Foot 600mm Kit

Joule-Samsung 16kW Monobloc Air Source Heat Pump

HHSM-G600016-1

Solution Key Features

- 7 year Warranty
- SCOP: Best on MCS Database – 4.42
- 65°C Hot Water
- <52DbdB - Quietest System on the Market
- 16Kw Outputs
- Low GWP Refrigerant – R32



AIR SOURCE HEAT PUMP

SYSTEM PRICE			INDOOR UNIT		
Ref Code	Ref Code Description	Dimensions (H x W x D)	Breaker (A) ²	Pipe Size (mm) ³	
Packaged					
HXSM-G6-014*	(HXSM-G6-019)*	SAMSUNG MONO 16 - 12.28KW 1PH 180L COMPACT	1900 x 595 x 620	32 & 32	28 / 22
HXSM-G6-134*	(HXSM-G6-139)*	SAMSUNG MONO 16 - 12.28KW 1PH 230L COMPACT	1900 x 595 x 620	32 & 32	28 / 22
Pre-Plumbed					
HXSM-G6-042*	(HXSM-G6-059)*	SAMSUNG MONO 16 - 12.28KW 1PH 200L STANDARD	1490x 740 x 740	32 & 32	28 / 22
HXSM-G6-043*	(HXSM-G6-060)*	SAMSUNG MONO 16 - 12.28KW 1PH 250L STANDARD	1815 x 740 x 740	32 & 32	28 / 22
HXSM-G6-044*	(HXSM-G6-061)*	SAMSUNG MONO 16 - 12.28KW 1PH 300L STANDARD	1600 x 800 x 800	32 & 32	28 / 22
HXSM-G6-073*	(HXSM-G6-087)*	SAMSUNG MONO 16 - 12.28KW 1PH 200L SOLAR	1510 x 545	32 & 32	28 / 22
HXSM-G6-074*	((HXSM-G6-088)*	SAMSUNG MONO 16 - 12.28KW 1PH 250L SOLAR	1760 x 545	32 & 32	28 / 22
HXSM-G6-075*	(HXSM-G6-089)*	SAMSUNG MONO 16 - 12.28KW 1PH 300L SOLAR	1980 x 545	32 & 32	28 / 22
Standalone					
HXSM-G6-004**	(HXSM-G6-009)**	SAMSUNG MONO 16 - 12.28KW 1PH SO SYS	422 x 393 x 87	Via ODU or 32	28 / 22
HXSM-G6-005**	(HXSM-G6-010)**	SAMSUNG MONO 16 - 12.28KW 3PH SO SYS	1420 x 940 x 330	32 & 32	28 / 22
Buffer					
HXSM-G6-102*	(HXSM-G6-117)*	SAMSUNG MONO 16 - 12.28KW 1PH JOULE HP MONO 200/60	1980 x 540	32 & 32	28 / 22
HXSM-G6-103*	(HXSM-G6-118)*	SAMSUNG MONO 16 - 12.28KW 1PH JOULE HP MONO 250/90	1670 x 600	32 & 32	28 / 22
HXSM-G6-104*	(HXSM-G6-119)*	SAMSUNG MONO 16 - 12.28KW 1PH JOULE HP MONO 300/13	1850 x 710	32 & 32	28 / 22
HXSM-G6-125*		SAMSUNG MONO 16 - 12.28KW 1PH JOULE HP MONO 400/13	2160 x 710	32 & 32	28 / 22

Included Components*: Outdoor Unit, Insulated Flexible Connection Pipes, 1" Y Pattern Strainer With Isolation and Pre Plumbed Cylinder

Included Components***: Outdoor Unit, Insulated Flexible Connection Pipes, 1" Y Pattern Strainer With Isolation and Mono Control Center

Recommended Components: 20l Concentrate Hp Fluid and Anti-Vibration Fix-It Foot 600mm Kit

Outdoor Unit

Ref Code	Description
HHSM-G600005-1	Mono 5 - 4.35kw R32 Ashp Outdoor Unit Std
HHSM-G600008-1	Mono 8 - 6.37kw R32 Ashp Outdoor Unit Std
HHSM-G600012-1	Mono 12 - 10.43kw R32 Ashp Outdoor Unit Std
HHSM-G600016-1	Mono 16 - 12.28kw R32 Ashp Outdoor Unit Std
HHSM-G600016-3	Mono 16 - 12.28kw R32 Ashp Outdoor Unit 3ph
HHSA-G60005-01	Mono 5 - 4.35kw R32 Ashp Outdoor Unit Coastal
HHSA-G60009-01	Mono 8 - 6.37kw R32 Ashp Outdoor Unit Coastal
HHSA-G60012-01	Mono 12 - 10.43kw R32 Ashp Outdoor Unit Coastal
HHSA-G60016-01	Mono 16 - 12.28kw R32 Ashp Outdoor Unit Coastal
HHSA-G60016-03	Mono 16 - 12.28kw R32 Ashp Outdoor 3ph Coastal

Indoor Unit

Ref Code	Description
Packaged	
HUGH-180COM-3C	180l R32 Mon Packaged Cylinder +3kw Imm
HUGH-230COM-3C	230l R32 Mon Packaged Cylinder +3kw Imm
Slimline	
HUGH-G6150-S3C	150l R32 1ph Hp Pre-Plumbed Slimline
HUGH-G6170-S3C	170l R32 1ph Hp Pre-Plumbed Slimline
Standard	
HUGH-G6150-L3C	150l R32 1ph Hp Pre-Plumbed Standard
HUGH-G6170-L3C	170l R32 1ph Hp Pre-Plumbed Standard
HUGH-G6200-L3C	200l R32 1ph Hp Pre-Plumbed Standard
HUGH-G6250-N3C	250l R32 1ph Hp Pre-Plumbed Standard
HUGH-G6300-N3C	300l R32 1ph Hp Pre-Plumbed Standard
Solar	
HUGS-G6200-L3C	200l R32 1ph Hp Pre-Plumbed Solar
HUGS-G6250-N3C	250l R32 1ph Hp Pre-Plumbed Solar
HUGS-G6300-N3C	300l R32 1ph Hp Pre-Plumbed Solar
Buffer	
HUGH-G61860-3C	180/60 R32 1ph Hp Pre-Plumbed Cyl Buff
HUGH-G62060-3C	200/60 R32 1ph Hp Pre-Plumbed Cyl Buff
HUGH-G62090-3C	200/90 R32 1ph Hp Pre-Plumbed Cyl Buff
HUGH-G62590-3C	250/90 R32 1ph Hp Pre-Plumbed Cyl Buff
HUGH-G63013-3C	300/130 R32 1ph Hp Pre-Plumbed Cyl Buff
HUGH-G64013-3C	400/130 R32 1ph Hp Pre-Plumbed Cyl Buff
HUGH-G61860-4C	180/60 R32 1ph Hp Pre-Plumbed Cyl Buff 3z
HUGH-G62060-4C	200/60 R32 1ph Hp Pre-Plumbed Cyl Buff 3z
HUGH-G62090-4C	200/90 R32 1ph Hp Pre-Plumbed Cyl Buff 3z
HUGH-G62590-4C	250/90 R32 1ph Hp Pre-Plumbed Cyl Buff 3z
HUGH-G63013-4C	300/130 R32 1ph Hp Pre-Plumbed Cyl Buff 3z
HUGH-G64013-4C	400/130 R32 1ph Hp Pre-Plumbed Cyl Buff 3z

Electrical

Ref Code	Description
PZI-A-0000000	Pv Ac Isolator
HZSMC-MIMH04EN	Samsung Wi-Fi Receiver 2.0 (Ehs) (Mim-H04en)
HZU-ELEC-MET	Emlite A100c Single Phase Kwh Meter - Mcs

Mechanical

Ref Code	Description
HZK-0C-0000020	20l Concentrate Hp Fluid
HZK-0H28-0.075	Insulated Flex Conn Pipes (28mm X 300mm) Elbow
HZK-0K-0000000	Anti-Vibration Fix-It Foot 600mm Kit
HZK-0Y-000001F	1" Y Pattern Strainer With Isolation
HZK-0P-0000000	Combined Fill Flush + Flow Met
HMPYK-0000012	12l Robokit Sealed System Kit + Br
HMPYK-0000018	18l Robokit Sealed System Kit + Br
HMPYK-0000024	24l Robokit Sealed System Kit + Br
HZK-0D-0000000	Heat Pump Wall Drip Tray (1100x400)
HZK-0J-0000000	Heat Pump Wall Bracket (Pair)
HZK-0V-0000028	28mm Iso Valve Red

Controller

Ref Code	Description
HZSMC-G6000000	MONO CONTROL CENTRE (MIM-E03CN) - GEN 6

UFH System Options

Joule provides state of the art underfloor heating with our Invaheat system. These simple to install and easy to use systems are accompanied with full UFH pipe installation layouts, upon request your chosen MEP installer can also be provided with "Underfloor Heating Installation & Maintenance Manual" demonstrating everything you need to know from Pre-installation Notes right through to system filling and testing.



Enjoy More Space

Since your heating system is underfoot, you have more space to make your own. No radiators makes way for cleaner lines, minimal clutter and a more contemporary ambience providing that open plan appeal.



Create Your Comfort Zone

Having precise control of the temperature throughout your home lets you create your perfect comfort zone, every day.

Choose from simple, standard and smart solutions to settle on the level of control that's ideal for you.

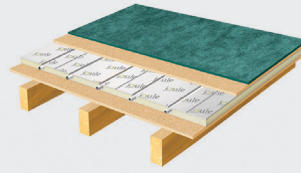

Inva Lite

Application	Floating Floor System
Thermal Output	65w/m ²
Floor Build-Up	25mm (On Hard Base) 43mm (On Joists)
Maximum Circuit Length	100m
Pipe Diameter/Material	16mm Pert/AL/Pert
Pipe Centres (mm)	100mm, 200mm
Drying Time	No Drying Time

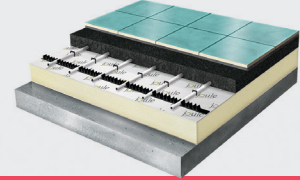

Inva Clip & Rail

Application	Solid Floor System
Thermal Output	90 w/m ²
Floor Build-Up	45-70mm
Maximum Circuit Length	100m
Pipe Diameter/Material	16mm Pert/AL/Pert
Pipe Centres (mm)	100mm, 150mm, 200mm
Drying Time	1 day/mm

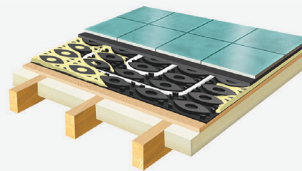

Inva Screenshot

Application	Overlay Floor System
Thermal Output	95w/m ²
Floor Build-Up	15mm (On Hard Base) 33mm (On Joists)
Maximum Circuit Length	75m
Pipe Diameter/Material	12mm Pert
Pipe Centres (mm)	100mm, 150mm, 200mm
Drying Time	8hr Foot Traffic 72hr Floor Covering

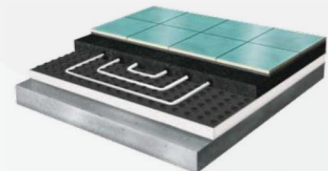

Inva Matt

Application	Solid Floor System
Thermal Output	90 w/m ²
Floor Build-Up	45-70mm
Maximum Circuit Length	100m
Pipe Diameter/Material	16mm Pert/AL/Pert
Pipe Centres (mm)	100mm, 150mm, 200mm
Drying Time	1 day/mm

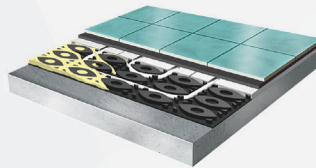

Inva Board

Application	Overlay Floor System
Thermal Output	65w/m ²
Floor Build-Up	18mm (On Hard Base) 36mm (On Joists)
Maximum Circuit Length	75m
Pipe Diameter/Material	12mm Pert
Pipe Centres (mm)	150mm,
Drying Time	8hr Foot Traffic 72hr Floor Covering

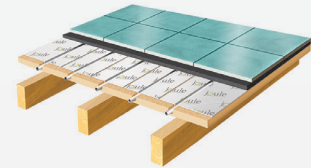

Inva Struct

Application	Suspended Floor System
Thermal Output	55w/m ²
Floor Build-Up	22mm
Maximum Circuit Length	75m
Pipe Diameter/Material	12mm Pert
Pipe Centres (mm)	100mm, 150mm, 200mm
Drying Time	No Drying Time

UFH System Primary Componant Specifcations



Save On Running Costs

Underfloor heating provides an efficient alternative to traditional heating methods.

By helping to distribute heat more evenly throughout your home it can help to reduce energy costs.



Electro-Thermal Acuator

Supply Voltage	230VAC, 50Hz
Output Voltage	230VAC, 50Hz
Max Load	70
No. Of Zone Outputs	42
Potential-Free Outputs	52
Dimensions (mm)	46

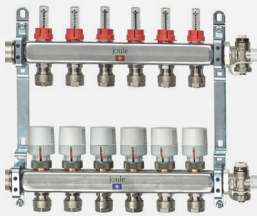

UFH Manifold

Field of Application	Heating/Floor Heating
Temperature Range	0°C to 70°C
Max Operating Pressure	6bar
Outlet Connection Sizes	3/4" Eurokonus
Material	Stainless Steel
No of Ports	3 - 13 Port

PortNo.	A (mm)	B (mm)
3	249	193
4	299	243
5	349	293
6	399	343
7	449	393
8	499	443
9	549	493
10	599	543
11	649	593
12	699	543
13	749	693



E.91 Touch Screen Heating Thermostat

Supply Voltage	220V/230V
Power Consumption	2W
Setting Range	70
Limitation Setting	42
Switch Differential	52
Ambient Temperature	46
IP Rating	IP20
Housing Material	Anti-Flammable PC



Mixing Valve & Controller

Temp. Range	5-95°C
Encloser Rating	IP41
Output Voltage	230VAC
Weight	0.40
Connection	1/2" Inch
A	36
B	72
C	32
D	50
E	36

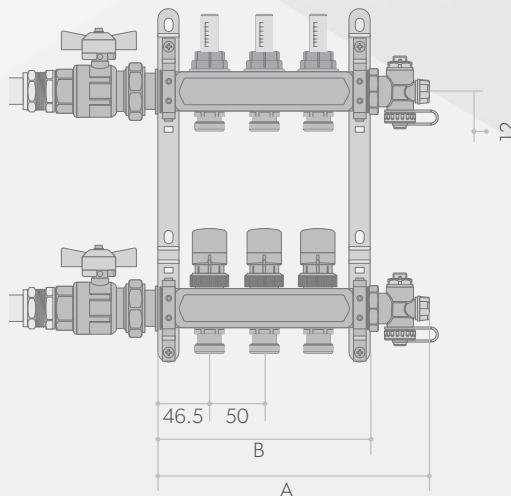

Wiring Centre

Supply Voltage	220V/230V
Output Voltage	2W
Max Load	70
No. Of Zone Outputs	42
Potential-Free Outputs	52
Dimensions (mm)	46

Aluminium Radiators

With its compact design and its attractive linear shape, RIVA provides a high thermal emission with a low water content and a reduced inertia.

The performance of this radiator perfectly combines with modern heating systems and is an effective response to the need for reduction of energy costs.

- Available in modular sections
- Ideal for use with Heat Pumps
- 15 years guarantee



Steel Radiators

Our competitive steel range has compact design paired with its high efficiency/ thermal emission making it the perfect choice for any heating systems.

- With or without hanger
- High efficiency,
- Suitable for low temperature
- Perfect corrosion resistance with nano-ceramic surface coating
- 10 year guarantee



Radiator Specs

Aluminium Radiators

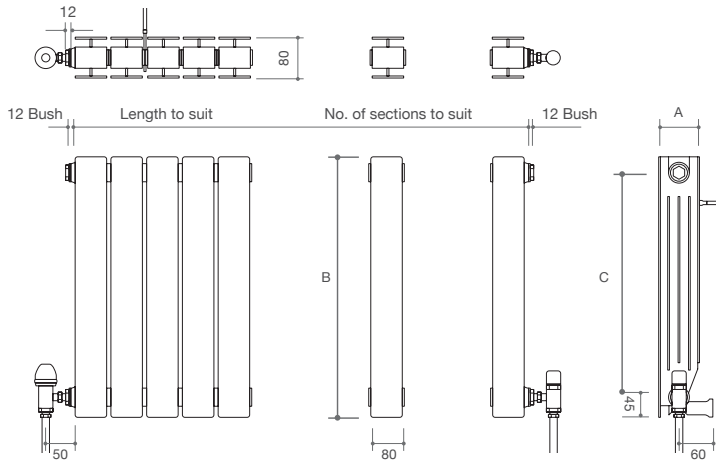

Dimensions				
	430	580	680	780
(A)	80mm	80mm	80mm	80mm
(B)	430mm	580mm	680mm	780mm
(C)	350mm	500mm	600mm	700mm

RADIATORS

Aluminium											
Release of Dangerous Substances	None										
	A1										
Maximum Operating Pressure	16 bar										
Test Pressure	27 bar										
	Aluminium Horizontal				Aluminium Vertical						
Height (mm):	430	580	680	780	1080	1280	1480	1680	1880	2080	
Km (Coefficient)	0.5667	0.62828	0.7582	0.7996	1.063	1.159	1.3	1.434	1.562	1.685	
n (Exponent)	1.2845	1.3262	1.3043	1.3332	1.312	1.326	1.327	1.329	1.33	1.331	
"Q t20 (Thermal effect) Watts per Section (80mm)"	26.58	33.39	37.73	43.39	54.14	61.55	69.25	76.85	83.96	90.84	
"Q t50 (Thermal effect) Watts per Section (80mm)"	86.23	112.55	124.67	147.21	180.13	207.45	233.60	259.70	284.00	307.56	

Steel Radiators

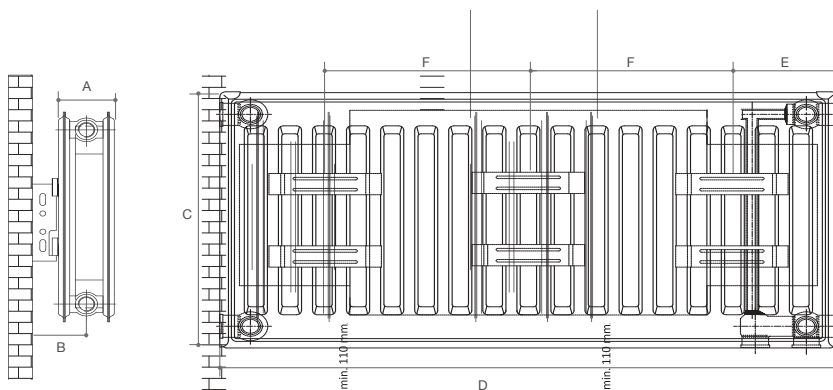

Dimensions		
	600	500
(A)	104 mm	104mm
(B)	83mm	83mm
(C)	600 mm	500mm
(D)	0.4 m - 2 m	0.4m - 2m
(E)	101 mm	101mm
(F)	(C-2D)/2	(C-2D)/2

Steel				
Release of Dangerous Substances	None			
	A1			
Maximum Operating Pressure	6 bar			
Test Pressure	10 bar			
	Steel Type 11		Steel Type 22	
Height (mm):	500	600	500	600
Km (Coefficient)	6.35134	7.33984	10.3724	11.4097
n (Exponent)	1.25304	1.25649	1.282	1.295
"Q t20 (Thermal effect) Watts per Section (80mm)"	271.09	316.53	482.84	552.21
"Q t50 (Thermal effect) Watts per Section (80mm)"	854.56	1000.98	1563.00	1809.01

Radiator Thermal Output Calculation

$$Q = Km * (\Delta T \wedge n)$$

ΔT = see table 2
 Km = see table below
 n = see table below

Table 2

ΔT = Mean Water Temp (°C) - Design Room Temp1 (°C).

Example: $\Delta T = 40 - 18$

Mean Water Temp °C = Heat Source Flow Temp (°C) - (System Temp Drop °C/2).

Example: MWT = 45 - (10/2)

Joule High efficiency solar Thermal systems

Mounting Angle $15-50^\circ$



Flat Roof Frame Opt.



Multiple Mounting



Remote Controlling



Spot In The Sun



Just like solar PV panels, a solar thermal system needs the sun as the main energy source. Therefore, the optimal position to be situated is somewhere with direct sunlight for the most part of the day.

However, they don't necessarily need to be placed on a roof. Other possible places could be on a flat roof or hang from a wall, as long as it gets direct sunlight.

Low Maintenance



Solar thermal panels require little maintenance and only occasional planned servicing. You only have to keep them relatively clean.

Renewable Energy Source



The most important benefit is that solar energy is a 100% renewable energy source. We will always have solar energy.

What Is a Solar Thermal Panel?

While solar PV panels use the energy from the sun to generate electricity, solar thermal panels use the sun to heat up water. As such, solar PV panels and solar thermals are two very different technologies.

Solar thermal uses free renewable energy from the sun which, just like the solar PV panels, will help you save money and reduce your carbon footprint.

Acapella Evacuated Tube System



TECHNICAL DATA	10 Tube	20 Tube	30 Tube
Certification Number	INT ST21013/2	INT ST21013/3	INT ST21013/5
Gross Area	1.72m ²	3.38m ²	4.901m ²
Aperature area	0.93m ²	1.86m ²	2.791m ²
Absorber Area	0.8m ²	1.61m ²	2.411m ²
Length of Tube	1.8m	1.8m	1.8m
Dist. Between Tubes/Panels	0.078m	0.078m	0.078m
Weight	52kg	85kg	106kg
Max Operating Pressure	6bar	6bar	6bar
Recommended Operating Pressure	2-3bar	2-3bar	2-3bar
Recommended Flow Rate	0.5l/min/m ²	0.5l/min/m ²	0.5l/min/m ²
Fluid Volume in Collector	0.81l	1.65l	2.3l
Rated Heat Output	0.60kW	1.21kW	1.81kW
Absorber	Aluminium		
Coating	Aluminium Nitrate		
Absorbance	> 94%		
Emissivity	<7%		
Mounting Frame	Aluminium Nitrate		
Glass	Borosiliate Glass		
Mounting Inclination	15°-75°		
Inlet Outlet Dimensions	3 ¼ bracket male		
Stagnation Temperature	200.3°C		
Insulation Material	Mineral Wool + Polyurethane		
Heat Transfer Fluid	Glycol Mix		
Dimensions L X W X D (M)	2.01m x 0.854m x 0.189m	2.01m x 1.68m x 0.189m	2.01m x 2.42m x 0.189m

SYSTEM PRICE

Item Number	Item Description	Roof Dimensions	Recommended Cylinder Size
W x L x H (mm)			
SX-E-00000020-T	20 TUBE SOLAR SYSTEM - TILE	1680 x 2010 x 189	200L
SX-E-00000020-S	20 TUBE SOLAR SYSTEM - SLATE	1680 x 2010 x 189	200L
SX-E-00000020-B	20 TUBE SOLAR SYSTEM - BOLT	1680 x 2010 x 189	200L
SX-E-00000030-T	30 TUBE SOLAR SYSTEM - TILE	2420 x 2010 x 189	250L
SX-E-00000030-S	30 TUBE SOLAR SYSTEM - SLATE	2420 x 2010 x 189	250L
SX-E-00000030-B	30 TUBE SOLAR SYSTEM - BOLT	2420 x 2010 x 189	250L
SX-E-00000040-T	40 TUBE SOLAR SYSTEM - TILE	3460 x 2010 x 189	300L
SX-E-00000040-S	40 TUBE SOLAR SYSTEM - SLATE	3460 x 2010 x 189	300L
SX-E-00000040-B	40 TUBE SOLAR SYSTEM - BOLT	3460 x 2010 x 189	300L

COMPONENTS INCLUDED

Item Number	Item Description	Quantity
SZ-L-OD-OERP5B	SOLAR PUMP	1
SVE-000000024	24L SOLAR EXPANSION VESSEL	1
SKU-000000020	20L SOLAR FLUID	1
OZM-00000.75HP	MIXING VALVE	1
SKT-0000000000	1M PIPE TAILS AND FITTINGS	2
SKN-C-00000ERP	SOLAR CONTROLER	1
SZ-OG-000004	SOLAR PIPE ENTRY GASKET SET 4"	1
	ROOF MOUNTING KIT	1

OPTIONAL EXTRAS

Item Number	Item Description
SVB-000000000P	SOLAR DISCHARGE - PLASTIC
SVS-0000000000	SOLAR EXP VESSEL CONNECT SET
SPD-16-50-0000	DN16 50M SOL SS PIPE DUO INS
SZ-J-0000DN-16	SOLAR FITTING JOINER PACK DN16

Navitas

2m/2.5m On Roof System

TECHNICAL DATA

	2M	2.5M
Certification Number	BBA 0192	
Collector type	Roof-mounted collector	
Overall area [m2]	2.02	2.34
Absorber area [m2]	1.85	2.15
Aperture area [m2]	1.93	2.23
L x W x H [mm]	1.730 x 1.170 x 73	2.000 x 1.170 x 73
Weight [kg]	31	32
Absorber capacity [l]	1.56	1.7
Housing	Al-frame	
Surface	Al, natural or anodized (improved corrosion resistance)	
Back plate	Al-sheet	
Absorber sheet	Al, high selectiv coated	
Absorption* [%]	95	
Emission* [%]	5	
Ø manifold [mm]	18 or 22 (¾ or 1")	
Ø risers [mm]	8	
Connections	blank (compression joint), coupling nut with flat seal	
Glass	3.2 mm tempered solar safety glass	
Transmittance of glass [%]	90	
Insulation	40 mm mineral wool plate	
Max. stagnation temperature	184 °C under test conditions	
Max. operating pressure	10 bar	
Proper heat transfer medium	Polypropylene glycol / water mixture	
Approved installation angle	min. 15°, max. 75°	
Packaging	Customer specific	

COMPONENTS INCLUDED

Item Number	Item Description	Quantity
SZ-LOD-OERP5B	SOLAR PUMP	1
SVE-000000024	24L SOLAR EXPANSION VESSEL	1
SKU-000000020	20L SOLAR FLUID	1
OZM-00000.75HP	MIXING VALVE	1
SKT-0000000000	1M PIPE TAILS AND FITTINGS	2
SKN-C-00000ERP	SOLAR CONTROLER	1
SZ-OG-000004	SOLAR PIPE ENTRY GASKET SET 4"	1
	ROOF MOUNTING KIT	1

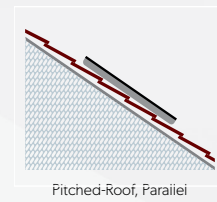
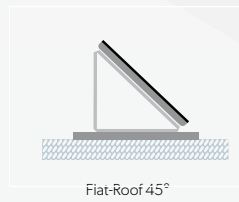

SYSTEM PRICE

Item Number	Item Description	Roof Dimensions W x L x H (mm)	Recommended Cylinder Size
SX-OR-2.0-0-02-S	2 PANEL 2M ON-ROOF SOLAR KIT - SLATE	2240 x 1730 x 83	250L
SX-OR-2.0-0-02-T	2 PANEL 2M ON-ROOF SOLAR KIT - TILE	2240 x 1730 x 83	250L
SX-OR-2.0-0-02-B	2 PANEL 2M ON-ROOF SOLAR KIT - BOLT	2240 x 1730 x 83	250L
SX-OR-2.5-0-02-S	2 PANEL 2.5M ON-ROOF SOLAR KIT - SLATE	2240 x 1730 x 83	250L
SX-OR-2.5-0-02-T	2 PANEL 2.5M ON-ROOF SOLAR KIT - TILE	2240 x 1730 x 83	250L
SX-OR-2.0-0-03-S	3 PANEL 2M ON-ROOF SOLAR KIT - SLATE	3710 x 1730 x 83	300L
SX-OR-2.0-0-03-T	3 PANEL 2M ON-ROOF SOLAR KIT - TILE	3710 x 1730 x 83	300L
SX-OR-2.0-0-03-B	3 PANEL 2M ON-ROOF SOLAR KIT - BOLT	3710 x 1730 x 83	300L
SX-OR-2.5-0-03-S	3 PANEL 2.5M ON-ROOF SOLAR KIT - SLATE	3710 x 1730 x 83	300L
SX-OR-2.5-0-03-T	3 PANEL 2.5M ON-ROOF SOLAR KIT - TILE	3710 x 1730 x 83	300L

OPTIONAL EXTRAS

Item Number	Item Description
SVB-000000000P	SOLAR DISCHARGE - PLASTIC
SVS-0000000000	SOLAR EXP VESSEL CONNECT SET
SPD-16-50-0000	DN16 50M SOL SS PIPE DUO INS
SZ-J-0000DN-16	SOLAR FITTING JOINER PACK DN16

Navitas

In Roof System

TECHNICAL DATA

Certification Number	BBA 0192
Collector type	Roof-mounted collector
Overall area [m2]	2.02
Absorber area [m2]	1.85
Aperture area [m2]	1.93
L x W x H [mm]	1.730 x 1.170 x 83
Weight [kg]	31
Absorber capacity [l]	1.56
Housing	Al-frame
Surface	Al, natural or anodized (improved corrosion resistance)
Back plate	Al-sheet
Absorber sheet	Al, high selectiv coated
Absorption* [%]	95
Emission* [%]	5
Ø manifold [mm]	18 or 22 (¾ or 1")
Ø risers [mm]	8
Connections	blank (compression joint), coupling nut with flat seal
Glass	3.2 mm tempered solar safety glass
Transmittance of glass [%]	90
Insulation	40 mm mineral wool plate
Max. stagnation temperature	184 °C under test conditions
Max. operating pressure	10 bar
Proper heat transfer medium	Polypropylene glycol / water mixture
Approved installation angle	min. 15°, max. 75°
Packaging	Customer specific

COMPONENTS INCLUDED

Item Number	Item Description	Quantity
SZ-L-OD-OERP5B	SOLAR PUMP	1
SVE-000000024	24L SOLAR EXPANSION VESSEL	1
SKU-000000020	20L SOLAR FLUID	1
OZM-00000.75HP	MIXING VALVE	1
SKT-0000000000	1M PIPE TAILS AND FITTINGS	2
SKN-C-00000ERP	SOLAR CONTROLER	1
	ROOF MOUNTING KIT	1



SYSTEM PRICE

Item Number	Item Description	Roof Dimensions	Recomended Cylinder Size
W x L x H (mm)			
SX-IR02.N-0001	1 PANEL 2M IN-ROOF SOLAR KIT		
SX-IR02.N-0002	2 PANEL 2M IN-ROOF SOLAR KIT	2840 x 2230 x 83	250L
SX-IR02.N-0003	3 PANEL 2M IN-ROOF SOLAR KIT	4310 x 2230 x 83	300L
SX-IR02.N-0004	4 PANEL 2M IN-ROOF SOLAR KIT		
SX-IR02.N-0005	5 PANEL 2M IN-ROOF SOLAR KIT		
SX-IR02.N-0006	6 PANEL 2M IN-ROOF SOLAR KIT		

OPTIONAL EXTRAS

Item Number	Item Description
SVB-000000000P	SOLAR DISCHARGE - PLASTIC
SVS-0000000000	SOLAR EXP VESSEL CONNECT SET
SPD-16-50-0000	DN16 50M SOL SS PIPE DUO INS
SZ-J-0000DN-16	SOLAR FITTING JOINER PACK DN16

What is a Victorium exhaust air heat pump?

A Victorium EAHP system Combines the aspects of both a conventional air source heat pump and a mechanical extract ventilation system (MEV) to provide 100% of the space heating requirements and DHW demand of a well insulated apartment unit. Ensuring compliance with domestic ventilation regulations and when working efficiently, it can reduce your home's energy consumption for heating by up to 50% when compared to conventional heating systems.

The system functions whereby latent heat from "wet rooms" i.e. kitchen, bathrooms and utility's is extracted via a system of ventilation ductwork to the unit. At the first stage of the process the extracted air passes through a heat exchanger into the sealed refrigerant circuit. The units compression cycle beings to raises the temperature of the refrigerant. The heat is then transferred into a water circuit and finally into either a DHW cylinder or space heating emitters like radiators or UFH systems. The cooled air is then discharged from the unit and exhausted outside.

Benefits Of The Victorium

The Victorium's control produces a very high and economical heat output. The Victorium gives you control over energy consumption and will be a key part of your connected lifestyle. The smart control system automatically adjusts to the indoor climate efficiently for maximum comfort.



- Stand alone heating, hot water & ventilation system
- Satisfies 100% of heating and hot water demand
- Whole house mechanical extract ventilation (MEV)
- Energy recycled from the apartment
- Full compliance with Part L and SAP using an all electric solution
- Lower running costs
- Heat pump COP of up to 490% (A20/W35)
- Lower capex and opex cost versus district heating
- No occupier standing charges or scheme management fees
- No gas connection, plantroom maintenance, metering or billing
- Maintenance via central BMS system which can be accessed remotely





Touchscreen Control Panel

Our Victorium EAHP system controller is responsible for controlling a variety of functions and features for your home including setting the time and temperature for your domestic hot water cylinder and central heating zones.

For information on all of the functionality of the touchscreen controller consult the homeowners operation and maintenance manual which is available upon request

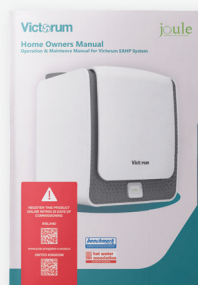

Product History & Development



Option 1:

Victorum EAHP & Pre-Plumbed Cyclone Cylinder

Victorum EAHP Specification

Item Number	HHH-2-0000-VHP	
Total Heating Capacity	5 Kw	
Total Compressor Output	2 Kw	
Max Circuit Amps (MCA)	28A	
Max Fuse Amps (MFA)	32A	
COP (A20, W35)	4.9	
Refrigerant	R134a	
Max Flow Temperature	60°C	
Max Vent Flow Rate Heating:	100-250m3/h	
Ventilation Rate Speed 1, 2, 3	50-350 m3/h	
Height:	570mm	
Width:	500mm	
Depth:	500mm	
Weight:	45kg	
Unit Connections:	15mm	
Air Inlet/ Outlet Connections:	150mm	
Certifications:		
For Space Heating	I.S. EN 14825	
For Hot Water	I.S. EN 16147	

Cyclone Cylinder Specification

Capacity	200L	250L
Item Number	TUVI-3-200-L2C	TUVI-2-250-L2C
	TUVI-3-200-L3C	TUVI-2-250-L3C

Cylinder Material	Stainless Steel Duplex LDX 2101	
Thermal Insulation	Polyurethane foam CFC-Free & HCFC Free	
Casing	Painted Galvanised Carbon Steel DX51D	
Coil Material	Stainless Steel Tube AISI 316L	
Weight (empty) kg	59 kg	69 kg
Weight (full) kg	256kg	315 kg
Max. Operating Pressure	5 (bar)	
Test Pressure	10 (bar)	
Max. Working Temperature	90°C	
Heating Elements	1. No. Incoloy Immersion	
Heat Loss	78 W	87 W
Heat up Time (mins)	31	37
Energy Efficiency Class C	C	

SAP Appendix Q

Kitchen + 1 Wet Room	0.32
Kitchen + 2 Wet Room	0.29
Kitchen + 3 Wet Room	0.29
Kitchen + 4 Wet Room	0.33
Kitchen + 5 Wet Room	0.39

EAHP Operation



- 1.1 Stand Alone heating, hot water & ventilation system
- 1.2 EAHP Unit to have the following built in components: Heat exchanger, Pump, Flow switch, Unit controls.
- 1.3 Hot water to be provided via manufacturers pre plumbed cylinder.
- 1.4 The EAHP will kick into operation to heat the cylinder as soon as a 5° dead band is reached to increase the operational efficiency of the system.
- 1.5 The system will provide central heating priority.
- 1.6 The System will incorporate an In-Line 3Kw back up emersion heater.
- 1.7 Accessories: Strainer, Fill & Flush, Isolation Valve, Remote Controller.
- 1.8 Optional Accessories: Victorum EAHP Unit is capable of integration with a district heating system with the inclusion of the "DM-MOD-EAHP District Heating Module – Victorum"

DHW Cylinder Operation

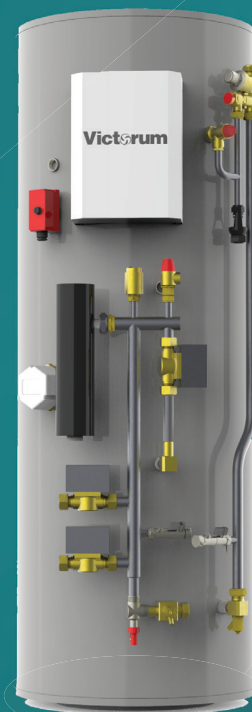

- 1.1 Joule Cyclone pre-plumbed / pre-wired Indirect DHW cylinder c.w Victorum system centre. wiring
- 1.2 1 bar working head c/w 3 port control valve.

Compact EAHP Operation

- 1.1 Stand Alone heating, hot water & ventilation system
- 1.2 EAHP Unit to have the following built in components: Heat exchanger, Pump, Flow switch, Unit controls.
- 1.3 Hot water to be provided via manufacturers pre plumbed cylinder.
- 1.4 The EAHP will kick into operation to heat the cylinder as soon as a 5° dead band is reached to increase the operational efficiency of the system.
- 1.5 The system will provide central heating priority.
- 1.6 The System will incorporate an In-Line 3Kw back up emersion heater.
- 1.7 Optional Accessories: Victorum EAHP Unit is capable of integration with a district heating system with the inclusion of the "DM-MOD-EAHP District Heating Module – Victorum"



Option 2: Victorum EAHP Compact

Victorum EAHP Specification

Item Number	HHH-3-0000-VHP
Total Heating Capacity	5 Kw
Total Compressor Output	2 Kw
Max Circuit Amps (MCA)	28A
Max Fuse Amps (MFA)	32A
COP (A20, W35)	4.9
Refrigerant	R134a
Max Flow Temperature	60°C
Max Vent Flow Rate Heating:	100-250m3/h
Ventilation Rate Speed	50-350 m3/h
Height:	2100mm
Width:	592mm
Depth:	672mm
Weight:	45kg
Air Inlet/ Outlet Connections:	150mm
Certifications:	
For Space Heating	I.S. EN 14825
For Hot Water	I.S EN 16147
Test Conditions	I.S EN 14511

Cyclone Cylinder Specification

Capacity	180L
Item Number	TUVI2C-180-L2C TUVI2C-180-L3C
Cylinder Material	Stainless Steel Duplex LDX 2101
Thermal Insulation	Polyurethane foam CFC-Free & HCFC Free
Coil Material	Stainless Steel Tube AISI 316L
Weight (empty) kg	47 kg
Weight (full) kg	244 kg
Max. Operating Pressure	5 (bar)
Test Pressure	10 (bar)
Max. Working Temperature	90°c
Heating Elements	1. No. Incoloy Immersion
Heat Loss	81 W
Energy Efficiency Class C	C

SAP Appendix Q

Kitchen + 1 Wet Room	0.32
Kitchen + 2 Wet Room	0.29
Kitchen + 3 Wet Room	0.29
Kitchen + 4 Wet Room	0.33
Kitchen + 5 Wet Room	0.39
Kitchen + 6 Wet Room	0.45

7
YEAR
WARRANTY



The innovative Smartplumb by Joule is a cylinder and buffer combined fully pre-plumbed, wired and programmed. The cylinder has the smallest footprint of any product of its type and built of industry leading components only.

Samsung's new generation heat pumps are smartphone compatible and benefit from remote monitoring for better service.



LOW NOISE
LEVEL



BEST IN CLASS
EFFICIENCY



ECO DESIGN
CERTIFIED



COMPATIBLE WITH OTHER HEAT
SOURCES

JOULE IE

mail Unit 407 NW Business Park, Cappagh Road,
Ballycoolin, Blanchardstown, Dublin
tel +353 (1) 623 7080
fax +353 (1) 626 9337
eml info@joule.ie
web www.joule.ie

JOULE UK

mail Valencia Park, 4 Gilcar Way, Castleford
West Yorkshire, WF10 5QS
tel +44 (0) 1513 551 094
fax +44 (0) 1513 568 336
eml info@jouleuk.co.uk
web www.jouleuk.co.uk

JOULE PL

mail ul. Strzegomska 55D, 53-611 Wrocław
tel +48 (0) 128811171
fax +48 (0) 814709046
eml biuro@joule-pl.pl
web www.joule-pl.pl